



SINCE // 1986

50 MILE PER HOUR

2016



SINCE // 1986

AFTER 30 YEARS OF INNOVATION, THE FUTURE HAS ARRIVED.

When we founded DPMS Panther Arms three decades ago, our primary mission was to provide precision M-16, M-14 and M203 parts to the U.S. Army. And deliver we did, helping convert their standard-issue rifles into high-performance machines. Since then, our legacy of fearless innovation and limitless customization has continued to grow.

Today, we're the second-largest manufacturer of AR rifles, and proud recipients of five prestigious NRA Golden Bullseye Awards—more than any other MSR brand. But we're not stopping there. Above all others, DPMS stands for performance, accuracy and reliability—the result of three decades of never, ever being satisfied with “good enough.” That same spirit of aggressive advancement led us to create the GII, the bold new standard of MSR, and the forerunner of next-generation AR design.

We've come a long way since 1986, and have transformed the industry with every stride forward. The good news is: We're just getting started.





CONTENTS

GII Intro	04
GII Features	06
GII Configurations	16
Tactical Rifles	26
DPMS Oracle	30
Hunting & Varmint Rifles	32
Standard Configurations	36
Competition Rifles	38
300 Blackout	40
Accessories	42
DPMS Factory Tour	80

**THE RADICAL
REINVENTION OF
THE .308 MSR.**



DESIGNED **II
DOMINATE.**



DPMS GII



GII FEATURES

WHAT SETS THE GII APART? EVERYTHING.



STANDARD M4 DIMENSIONS

STANDARD AR FIRE CONTROL AND
TAKE DOWN COMPONENTS.
IMPROVED HAMMER & TRIGGER PINS

FORGED LOWER RECEIVER
WITH INTEGRAL ENHANCED
TRIGGERGUARD



GII IMPROVEMENT RESULT

- + RELIABILITY
- + LIGHTWEIGHT
- + IMPROVED HANDLING
- + INCREASED DURABILITY
- + LONGEVITY
- + VERSATILITY
- + ADAPTABILITY



REDUCED OVERALL LENGTH & WEIGHT

FORGED UPPER RECEIVER WITH STANDARD AR FORWARD ASSIST AND IMPROVED SHELL DEFLECTOR

ENLARGED EJECTION PORT

STANDARD AR DIMENSIONS FROM BORE TO GAS TUBE, AND BORE TO RAIL, ALLOW FOR INCREASED .223 HANDGUARD COMPATABILITY AND ADDITION OF SIGHTS OR OPTICS

STEEL FEED RAMP

BEVELLED MAG WELL

REDUCED MASS, FORGED, MONOLITHIC BOLT CARRIER WITH FORWARD ASSIST

IMPROVED EXTRACTOR & ELASTOMER EXTRACTOR SPRING

DUAL EJECTORS



“WE HAVE
DEVELOPED
THE BEST AR ON
THE MARKET.”

Adam Ballard

Adam Ballard / DPMS Product Manager

The DPMS GII is the collective culmination of decades of experience in the shop, on the range, or in the field, chasing everything from wild game and titles to our nation's enemies.

The GII is all about taking a great product with a great history, and applying the best R&D methods to improve it. Making it simply the most advanced, most versatile and reliable AR platform you can buy.

Some other manufacturers are content with imitating, and might have stopped with a new forged receiver. But for us, that was just the beginning. We didn't just reconfigure another AR. We didn't just slap together a few aftermarket components or grow an existing rifle to a larger cartridge. We have fundamentally redefined the way the AR works.

UNFAILING RELIABILITY.

Revolutionary improvements make the GII the most reliable, longest lasting AR platform on the market. Key to this are: an all new elastomer extractor spring, new extractor material, dual ejectors, and a steel insert feedramp. These components fundamentally change the way the conventional AR functions.

THE BIGGEST REVOLUTION TO THE GII MIGHT JUST BE THE SMALLEST.

○ IMPROVED EXTRACTOR & ELASTOMER EXTRACTOR SPRING

Through countless hours of research, testing, and tens of thousands of fired rounds, DPMS selected:

- A new extractor material that is nearly impossible to break
- A patent pending elastomer extractor spring capable of enduring tens of thousands of cycles without fatigue, breakage, failure; can resist temperatures from -60°F to $650^{\circ}\text{F}+$; and resist every gun cleaner, solvent, oil or degreaser we could get our hands on.

▬ DUAL EJECTORS

Dual ejector system reduces ejector spring fatigue. Through duplication, the likelihood of a failed ejection is significantly reduced.

▬ STEEL FEED RAMP

GII incorporates an inserted steel feed ramp, allowing a lighter, smaller barrel extension and receiver while improving feeding of more ammunition types.

▬ ENLARGED EJECTION PORT

Lengthened port allows for better, more consistent ejection.

DRY CYCLE ENDURANCE OF ELASTOMER SPRING

Elastomer Fatigue

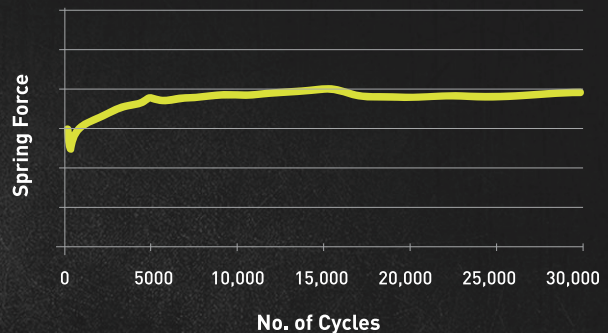

NEW EXTRACTOR AND ELASTOMER EXTRACTOR SPRING PROVIDE OUTSTANDING FUNCTIONAL, ENDURANCE, AND ENVIRONMENTAL RESISTANCE IMPROVEMENTS.

ENHANCED EXTRACTOR SPRING RESISTS TEMPERATURES

-60°F to $650^{\circ}\text{F}+$



IMPROVED EXTRACTOR &
ELASTOMER EXTRACTOR SPRING

THE RESULT

THE MOST CONSISTENT,
EFFICIENT, AND RELIABLE
EXTRACTION AND EJECTION
PATTERN OF ANY AR.

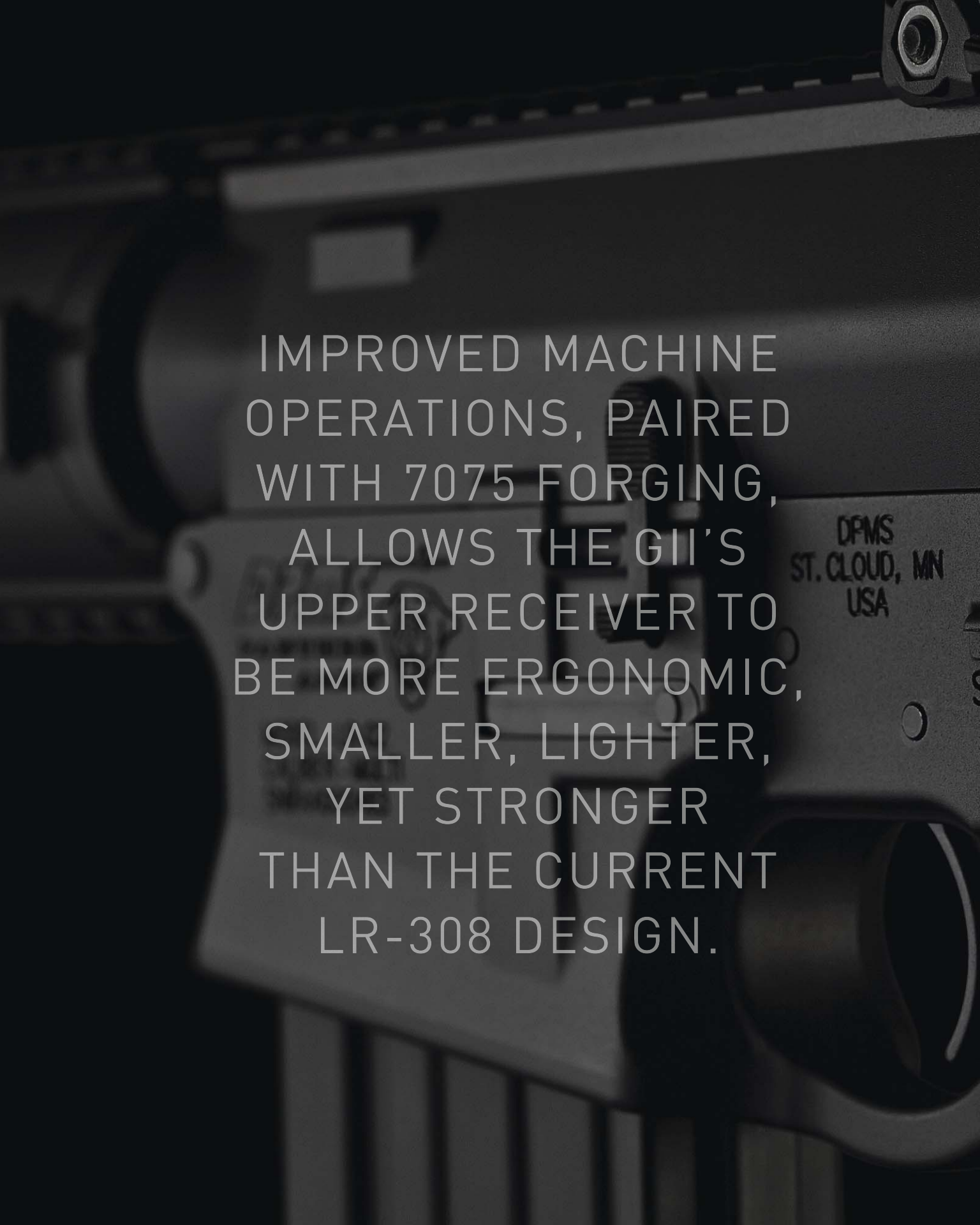
A close-up, black and white photograph of a rifle receiver. The receiver is the central part of the rifle that houses the action. It features a bolt handle on the left and a magazine well on the right. The text is overlaid in a clean, white, sans-serif font. On the right side of the receiver, there is a small, rectangular stamp that reads "DFMS ST. CLOUD, MN USA".

IMPROVED MACHINE
OPERATIONS, PAIRED
WITH 7075 FORGING,
ALLOWS THE GII'S
UPPER RECEIVER TO
BE MORE ERGONOMIC,
SMALLER, LIGHTER,
YET STRONGER
THAN THE CURRENT
LR-308 DESIGN.

DFMS
ST. CLOUD, MN
USA

BUTT TO BORE, THE RADICAL REINVENTION OF THE .308 MSR.

The heart of the GII is a matched pair of forged, level III anodized, Teflon coated 7075 receivers, providing improved strength and durability.

THE RIFLE SIMPLY FEELS BETTER WHEN YOU PICK IT UP.

○ FORGED UPPER & LOWER RECEIVERS

Forged upper and lower receivers are contoured to be more ergonomic. Compact design is both lightweight and only 1/2" longer than a 5.56 AR receiver, 5/8" shorter than the current LR-308.

Lower receiver incorporates integral trigger guard and accepts any standard AR pistol grip.

— REDUCED MASS, FORGED, MONOLITHIC BOLT CARRIER WITH FORWARD ASSIST

New lightweight, forged, monolithic bolt carrier utilizes an integral gas key tower and removable gas key extension.

△ REDUCED WEIGHT, YET LIGHTER RECOIL

Reduced mass carrier provides smoother, softer recoil impulse than the GEN1 .308.

⬡ IMPROVED BOLT AND BARREL EXTENSION

An all new bolt geometry provides superior lockup and strength. The bolt geometry allows a smaller diameter barrel extension to be used, in turn allowing upper receiver to be smaller, reducing overall material and weight without compromising strength.

▭ BEVELED MAG WELL

The beveled mag well provides a comfortable grip for those that prefer a mag well hold and also aids in quicker mag changes.

THE RESULT

WITH THE ADVANCEMENTS IN THE FORGING, FEED RAMPS AND BOLT GEOMETRY, THE GII HAS A SHORTER OVERALL RECEIVER LENGTH, AS WELL AS A REDUCED RECEIVER DIAMETER.

ADAPTABLE. VERSATILE.

With its adaptability in accepting standard AR fire control and more .223 two-piece handguards than before, the GII core also remains versatile in both tactical and hunting configurations. A true game-changer.

ALL THE ACCURACY YOU'D EXPECT FROM DPMS.

➤ INCREASED .223 PLATFORM HANDGUARD ADAPTABILITY

Accepts more 2-piece AR handguards than previous LR-308. Newly designed barrel nut allows the use of .223 diameter free float handguard systems.

☐ ACCEPTS STANDARD AR FIRE CONTROLS

DPMS GII rifles accept standard AR fire controls for even more adaptability.

☐ AN EXCEPTIONAL TACTICAL RIFLE

Contoured steel feed ramps, revolutionary redesigned extraction system, and a dual ejector design decrease feeding, extraction and ejection malfunctions.

Completely re-designed gas delivery system utilizes a monolithic bolt carrier and optimized gas ring clearances to eliminate the possibility of gas leakage during operation.

➤ DESIGNED TO HUNT

GII is specifically designed for the mobility required to have a successful hunt by achieving weight and length reduction when compared to the original, time-proven LR-308. The design of the GII has been optimized to function with all available hunting ammunition types.



THE RESULT

**DESIGNED TO
RUN FLAWLESSLY.**

GII CONFIGURATIONS 2016

16" LIGHTWEIGHT CARBINE

16" RECON CARBINE

16" LIGHTWEIGHT MOE CARBINE

18" SASS RIFLE

20" LIGHTWEIGHT HUNTER

24" BULL

16" LIGHTWEIGHT COMPACT HUNTER

MORE NRA GOLDEN BULLSEYE AWARDS THAN ANY OTHER MSR BRAND



Rifle of the Year



Tactical Gun of the Year



Rifle of the Year



Rifle of the Year



Rifle of the Year

GII AP4 / GII RECON / GII MOE / GII SASS / GII HUNTER

GII BULL / GII COMPACT HUNTER

CARBINE
DE CARBINE
UNTER



DESIGNED **II DOMINATE.**

GII ^{+ 16" LIGHTWEIGHT CARBINE} AP4

BUILT ON AWARD-WINNING BADASSNESS.

The 16" GII AP4 is everything you would expect from an improvement to the award winning LRAP4, which was the second AR to win an NRA Golden Bullseye Award. Which AR was the first you ask? None other than the DPMS 24" LR308. Lightweight 16" barrel, AP4 Stock, DPMS carbine length Glacier Guard and Magpul Gen 2 rear sight.



RFLR-G2AP4 (60220)

\$1399

.308 > 7.62 NATO

RFLR-G2AP4 + 16" LIGHTWEIGHT CARBINE

CALIBER .308 / 7.62 NATO		LENGTH 34.25" (COLLAPSED)	WEIGHT 7.25 LBS
BARREL 16" Lightweight 4150 Chromelined	TWIST 1x10	FIRE CONTROL Std AR	
UPPER RECEIVER Forged 7075 T6 Lvl 3 Anodized, Teflon coated, A3 Type		LOWER RECEIVER Forged 7075 T6 Lvl 3 Anodized, Teflon® coated	
STOCK M4 6 Position Collapsible	PISTOL GRIP A2	FRONT/REAR SIGHT F Marked Front Sight Base, Magpul BUIS	
FLASH HIDER Cancellation Brake	HANDGUARD Glacier Guard		



GII RECON

+ 16" RECON CARBINE

8.5 POUNDS OF FREEDOM, ONE SERIOUSLY BADASS RIFLE.

The 16" GII Recon is just as capable as the original .308 Recon, but weighs less. You can run it at your next carbine course without needing to look like a bodybuilder. 16" stainless steel and bead blasted barrel; DPMS hunter gas block; 4 rail free float tube; and Magpul MOE pistol grip and stock.



RFLR-G2REC (60222)

\$1659

.308

7.62 NATO

RFLR-G2REC + 16" RECON CARBINE

CALIBER .308 / 7.62 NATO		LENGTH 38"	WEIGHT 8.5 LBS
BARREL 16" 416 Stainless, Bead Blasted Mid-Length Gas		TWIST 1x10	FIRE CONTROL DPMS 2 Stage
UPPER RECEIVER Forged 7075 T6 Lvl 3 Anodized, Teflon coated, A3 Type		LOWER RECEIVER Forged 7075 T6 Lvl 3 Anodized, Teflon® coated	
STOCK Magpul MOE 6 Position Collapsible Stock		PISTOL GRIP Magpul MOE	FRONT/REAR SIGHT Magpul Front and Rear BUIS
FLASH HIDER Advanced Armament 51T Blackout Silencer Adapter		HANDGUARD DPMS 4 Rail Free Float Tube	



GII MOE

+ 16" LIGHTWEIGHT MOE CARBINE

A HEAVY HITTER IN A SMALL PACKAGE.

The GII MOE Carbine is tailor-made for .308 shooters who demand big centerfire performance in a compact rifle. This rifle tips the scale at only 7.25 lbs. Add in the complete MOE furniture kit and you have one badass enhanced carbine, guaranteed to turn heads at the range.



RFLR-G2MOE (60232)

\$1499

.308 7.62 NATO

RFLR-G2MOE + 16" LIGHTWEIGHT MOE CARBINE

CALIBER .308 / 7.62 NATO		LENGTH 34.25" (COLLAPSED)	WEIGHT 7.25 LBS
BARREL 16" Lightweight 4150 Chromelined	TWIST 1x10	FIRE CONTROL Std AR	
UPPER RECEIVER Forged 7075 T6 Lvl 3 Anodized, Teflon coated, A3 Type		LOWER RECEIVER Forged 7075 T6 Lvl 3 Anodized, Teflon® coated	
STOCK MOE Carbine Stock Commercial Spec	PISTOL GRIP Magpul MOE	FRONT/REAR SIGHT F Marked Front Sight Base, Magpul BUIS	
FLASH HIDER Cancellation Brake	HANDGUARD MOE Carbine-Length AR15/M16		



GII SASS

+ 18" SASS RIFLE

A HERITAGE OF SWAT SNIPER PRECISION.

The 18" GII SASS of the original SASS used by Law Enforcement agencies and SWAT teams across the country. Take that tried and true performance of the SASS throw it into a more versatile and lighter sniper platform, and you get a match made in long range heaven.

- 30% weight reduction
- 18" fluted stainless barrel
- 4 rail free float tube
- Harris Bi-Pod and adapter
- Magpul PRS stock and Gen 2 MBUS



RFLR-G2SASS (60230)
\$2279

.308 → 7.62 NATO

RFLR-G2SASS + 18" SASS RIFLE

CALIBER .308 / 7.62 NATO		LENGTH 39"		WEIGHT 10.5 LBS	
BARREL 18" 416 Stainless, Teflon Coated, Fluted Bull Barrel, Mid-Length Gas			TWIST 1x10		FIRE CONTROL DPMS 2 Stage
UPPER RECEIVER Forged 7075 T6 Lvl 3 Anodized, Teflon coated, A3 Type			LOWER RECEIVER Forged 7075 T6 Lvl 3 Anodized, Teflon® coated		
STOCK Magpul PRS Rifle Stock		PISTOL GRIP Panther Tactical Grip		FRONT/REAR SIGHT Magpul Front and Rear BUIS	
FLASH HIDER Panther Flash Hider			HANDGUARD DPMS 4 Rail Free Float Tube		



GII HUNTER

+ 20" LIGHTWEIGHT HUNTER

MODERN DESIGN FOR TRADITIONAL HUNTING.

The 20" GII .308 Hunter is exactly that, a hunter! This gun is deadly accurate, loaded with features and benefits, but light enough to carry all day in the woods/plains/snow/desert. 20" target crown lightweight stainless steel barrel, enhanced carbon fiber free float tube, Hogue® grip, and Magpul MOE rifle stock.



RFLR-G2308L (60238)

\$1599

.308 7.62 NATO

RFLR-G2308L + 16" LIGHTWEIGHT HUNTER

CALIBER .308 / 7.62 NATO		LENGTH 39" (COLLAPSED)	WEIGHT 7.76 LBS
BARREL 20" 416 Stainless, Teflon coated	TWIST 1x10	FIRE CONTROL DPMS 2 Stage	
UPPER RECEIVER Forged 7075 T6 Lvl 3 Anodized, Teflon coated, A3 Type		LOWER RECEIVER Forged 7075 T6 Lvl 3 Anodized, Teflon® coated	
STOCK Magpul MOE Rifle Stock	PISTOL GRIP Hogue	FRONT/REAR SIGHT N/A	
FLASH HIDER None - Target Crown	HANDGUARD DPMS Carbon Fiber Free Float		



GII ^{+24" BULL} BULL

TACK-DRIVING BENCHREST PRECISION. RELIABLE AR PERFORMANCE.

The 24" GII LR 308 is every bit as accurate as the original award winning bench rest shooter, but in a 20% lighter package. The diehard long range DPMS fans now have a new toy to show off at the range. 24" stainless steel bull barrel, standard length free float tube, and A2 Mil Spec buttstock.



RFLR-G2B24 (60236)
\$1299

.308 **7.62 NATO**

RFLR-G2B24 +24" BULL

CALIBER .308 / 7.62 NATO	LENGTH 43"	WEIGHT 10 LBS
BARREL 24" 416 Stainless Bull	TWIST 1x10	
UPPER RECEIVER Forged 7075 T6 Lvl 3 Anodized, Teflon coated, A3 Type		LOWER RECEIVER Forged 7075 T6 Lvl 3 Anodized, Teflon [®] coated
PISTOL GRIP A2	FRONT/REAR SIGHT N/A	
FLASH HIDER None - Target Crown	HANDGUARD DPMS Aluminum Free Float	



GII CONFIGURATIONS 2016

GII + 16" LIGHTWEIGHT COMPACT HUNTER COMPACT HUNTER

6.9 LBS OF PURE BIG-GAME KNOCK-DOWN.

The GII Compact Hunter packs big-game punch in a lightweight MSR that's as easy to handle as it is easy-to-carry. At only 6.9 lbs., it delivers full-size power and accuracy in a versatile solution that's built to hunt. Features include 16" 416 stainless steel, teflon-coated barrel, free-floating carbon-fiber handguard, Hogue® pistol grip and B5 Sopmod stock. Available in .308.



RFLR-G2C308L (60556)

\$1599

.308

RFLR-G2C308L + 20" LIGHTWEIGHT COMPACT HUNTER

CALIBER .308	LENGTH 32.5"-36"	WEIGHT 6.9 LBS
BARREL 16" Midlength 416 Stainless Teflon Coated	TWIST 1x10	FIRE CONTROL DPMS 2 Stage
UPPER RECEIVER Forged GII A3 Type	LOWER RECEIVER Forged 7075 GII	
STOCK B5 Sopmod	PISTOL GRIP Hogue	FRONT/REAR SIGHT N/A
FLASH HIDER None	HANDGUARD Carbon Fiber Free Float	





TACTICAL RIFLES

DPMS	TAC2	27
DPMS	TPR	28
DPMS	RECON	28
DPMS	LITE 16	29





DPMS TAC2

DPMS M111 MODULAR HANDGUARD SYSTEM



MAGPUL
ACS STOCK

MOE GRIP

INNOVATIVE DESIGN PROVEN PERFORMANCE.

Enhanced as it is adaptable. Built upon the foundation that a longer sight radius allows for a better sight picture, thus improving accuracy. Features Magpul ACS stock, MOE grip, and the DPMS M111 modular handguard system. Built, tested and suited for any situation imaginable.

8.5
LBS

CHAMBERED IN:

.223

5.56

RFA3-TAC2
(60545)
\$1249

DPMS TPR

The Tactical Precision Rifle is built for exactly that. A 20" Stainless bead blasted barrel, that's matched with DPMS M111 modular handguard, Magpul® MOE® grip and Magpul® MOE® Rifle stock allows for comfortable handling and full-size rifle velocity.

AVAILABLE IN
THESE CALIBERS:



RFA3-TPR (60546)
\$1249



WEIGHT
7.65
LBS

WEIGHT
7.75
LBS



DPMS RECON

The tactical carbine brought to new heights. The DPMS Recon is one of the sharpest looking ARs on the market today. It delivers accuracy without the weight of a full-size precision rifle. Equipped with the Magpul MOE stock, grip, enhanced trigger guard, and back-up sights.

AVAILABLE IN THESE
CALIBERS:



RFA3-REC (60542)
\$1197

DPMS LITE 16

Finally, you can have it all.

Some people like sights, some of us want optics, some want a featherweight rifle - this is all three. With the DPMS A3 Lite 16, all you'll need to do is add your own optics, back up sights or carry handle and you'll be ready to go.

AVAILABLE IN THESE
CALIBERS:

RFA3-L16 (60525)
\$829

5.56



WEIGHT
6.0
LBS



223/308 DPMS ORACLE

DPMS

ORACLE

31





DPMS .308 ORACLE

Ready to hunt and born to turn heads.

The .308 Oracle (shown below), much like its 5.56 little brother, is one of our most popular rifles, because of its compact size, rugged military carbine features and .308 firepower.

AVAILABLE IN
THESE CALIBERS:



RFLR-OC (60560)
\$954



WEIGHT
8.3
LBS

WEIGHT
6.4
LBS



DPMS .556 ORACLE

Quite possibly our best value yet.

This lightweight optics ready carbine features a mil-std A3 upper receiver, lightweight barrel and Pardus stock for user comfort and advanced capability. All of this and plenty more, at a price set for any budget.

AVAILABLE IN
THESE CALIBERS:



RFA3-OC (60531)
\$654

HUNTING & VARMINT RIFLES

PRAIRIE
PANTHER

BRUSH

33

PRAIRIE
PANTHER

**KINGS SNOW
SHADOW**

34

PRAIRIE
PANTHER

SWEET 16

34

DPMS

BULL 20

35

DPMS

BULL 24

35





PRAIRIE PANTHER BRUSH



MOSSY OAK BRUSH CAMO



●
VERY
LIGHT

●
TEFLON® COATED,
STAINLESS BARREL

THE LIGHTEST, MOST ACCURATE RIFLE FOR CALLING AND STALKING. PERIOD.

The DPMS Prairie Panther is our premier lightweight .223 hunting rifle and comes standard with the DPMS 2-Stage Trigger, a 20" fluted, Teflon® coated, stainless barrel, carbon fiber handguards, Tac latch, and A2 stock . Not to mention the Mossy Oak® Brush® camouflage pattern.

7.15
LBS

CHAMBERED IN:

.223

RFA3-PPB
(60539)
\$1249

PRAIRIE PANTHER KINGS DESERT SHADOW

The lightest, most accurate rifle for calling and stalking. Period. The DPMS Prairie Panther is our premier lightweight .223 hunting rifle and comes standard with the DPMS 2-Stage Trigger, a 20" fluted, Teflon® coated, stainless barrel, carbon fiber handguards, Tac latch, and A2 stock.

AVAILABLE IN
THIS CALIBER:

RFA3-PPD (60540)
\$1249



WEIGHT
7.99
LBS

WEIGHT
7.15
LBS



PRAIRIE PANTHER SWEET 16

One of the sweetest shooting carbines you'll ever find. The DPMS Sweet 16 comes with a free-float 16" stainless steel bull barrel and is fully capable of full-size accuracy. Yet, it's short and light enough to handle easily or carry directly to your hunting spot.

AVAILABLE IN
THIS CALIBER:

RFA2-B16 (60507)
\$979



DPMS BULL 20

Erase varmints with supreme accuracy. Our most popular bull barrel .223 Rem rifle, the DPMS Bull 20 is the standard for all bull barreled AR rifles.

AVAILABLE IN THIS CALIBER:



RFA2-BULL20-A3 (60509)
\$989



WEIGHT
9.8
LBS

WEIGHT
9.5
LBS



DPMS BULL 24

Otherwise known as a prairie dog's worst nightmare. The DPMS Bull 24 comes equipped with a free-float 24" stainless bull barrel and delivers more than enough power to forever intimidate any type of varmint that happens to cross your path.

AVAILABLE IN THIS CALIBER:



RFA2-B24 (60508)
\$999

STANDARD CONFIGURATIONS

DPMS

AP4 CARBINE

37





DPMS AP4 CARBINE



TRUSTED

BEST SELLING
DPMS RIFLE

EFFICIENT

BUILT TO BE AS TOUGH AS THE MISSION AHEAD.

The DPMS AP4 Carbine has been sold to thousands of law enforcement officers, agencies, civilian contractors, military, and countless US service members. No wonder the AP4 is the most trusted and best-selling AR rifle in the history of DPMS.

7.4
LBS

CHAMBERED IN:

.223

5.56

RFA2-AP4A
(60505)
\$945

COMPETITION

DPMS **LBR** 39

DPMS **3G1** 39





DPMS LBR

The best all-around lightweight carbine out on the range.
 The LBR just might be the ultimate carbine for someone needing a compact rifle without all the tactical frills. Don't let the lightweight barrel or overall size fool you, the stainless barrel comes from the same blanks we use to make our premier sporting barrels.

AVAILABLE IN
THESE CALIBERS:



RFA3-LBR (60527)
\$979



WEIGHT
7.75
LBS

WEIGHT
7.25
LBS



DPMS 3G1

DPMS' first and most popular 3-Gun rifle in both .223 and .308.
 The DPMS 3G1 brings the most preferred custom match rifle features to the range directly from a factory box. These rifles tear down any financial barriers to entering the competitive multi-gun community.

AVAILABLE IN
THESE CALIBERS:



RFA3-3G1 (60521)
\$1299

300 BLACKOUT

DPMS
300

BLACKOUT

40





DPMS BLACKOUT

DPMS M111 MODULAR FREE FLOAT TUBE



A2 PISTOL GRIP

AAC M42000
FLASH HIDER

BUILT TO ORDER, BUILT FOR DUTY.

Smash the stereotypes. Based on the innovative 300 AAC® BLACKOUT® cartridge, this rifle has the new DPMS M111 modular free-float tube, so you choose how much rail you want. Comes equipped with either a sleek AAC® BLACKOUT® suppressor adapter, or an inert, slipover mock suppressor. No special bolts or mags required.

7.5
LBS

CHAMBERED IN:

300 AAC BLACKOUT

RFA3-300SR
(60520)
\$1149



BUILT. TESTED. PERFECTED.

RIGHT HERE IN HUNTSVILLE, ALABAMA

All DPMS™ firearms are expertly manufactured in Huntsville, Alabama. Our hardworking men and women take great pride in every rifle and part that we ship.

DPMS separates itself from the rest with our attention to detail: whether assembling sights, staking gas keys, or test firing before shipping - DPMS is committed to building you the best quality rifle as if it were our own. As always, we can help you customize your DPMS rifle for your special purpose right out of our factory.

At DPMS, we are very proud to offer the most comprehensive and customizable line of any major AR manufacturer.



DPMS LOWER RECEIVERS

.308 LOWER RECEIVERS

STRIPPED LOWER RECEIVER

.308 Winchester

Milled from a solid billet of 6061-T6 aluminum
Hard coat anodized per Mil-Spec and Teflon®
coated black

Integral trigger guard

FFL required for purchase



308-LR-05K
\$409.95



308-LR-05TL
\$459.95

.223 LOWER RECEIVERS

STRIPPED LOWER RECEIVER

Milled from a solid billet of 6061-T6 aluminum
Hard coat anodized per Mil-Spec and Teflon®
coated black

Integral trigger guard

FFL required for purchase



LR-05K
\$189.95



LR-05-TL
\$209.95

LOWER RECEIVERS

WITH LOWER RECEIVER PARTS KIT INSTALLED

Kit includes the following lower receiver parts:

pistol grip / trigger / hammer / disconnecter /
selector bolt catch spring / detent spring /
front pivot pin / hammer spring / trigger spring
pistol grip screw / pistol grip lock washer /
selector spring / selector detent / bolt catch
buffer / take down detent / bolt catch / magazine
catch spring / bolt catch roll pin / magazine /
catch button / magazine catch / hammer pin /
trigger pin / take down pin / buffer retainer pin /
buffer retainer spring



LR-05LP
\$244.95



308-LR-05LP
\$490.95

DPMS LOWER RECEIVER ASSEMBLIES

.308 LOWER RECEIVER ASSEMBLY

Milled from a solid billet of 6061-T6 aluminum
Hard coat anodized per Mil-Spec and Teflon®
coated black

Integral trigger guard

FFL required for purchase

Assembly includes: Fully assembled .308 DPMS
lower receiver, A2 pistol grip & your choice of any
of these featured buttstock assemblies:

A2 BUTTSTOCK ASSEMBLY



308-LR-05ASF
\$689.95

AP4 BUTTSTOCK ASSEMBLY



308-LR-05CS
\$689.95

VISIT WWW.DPMSINC.COM FOR THOUSANDS MORE
PARTS AND ACCESSORIES FROM DPMS AND YOUR
OTHER FAVORITE BRANDS.

5.56 LOWER RECEIVER ASSEMBLY

Forged 7075-T6 aircraft aluminum alloy
Hard coat anodized per Mil-Spec and Teflon®
coated black

FFL required for purchase

Assembly includes: Fully assembled DPMS lower
receiver, A2 pistol grip & your choice of any of
these featured buttstock assemblies:

A2 BUTTSTOCK ASSEMBLY



LR-05ASF
\$367.95

AP4 BUTTSTOCK ASSEMBLY



LR-05AP4
\$367.95

PARDUS BUTTSTOCK ASSEMBLY



LR-05PS
\$359.95

DPMS BARREL ASSEMBLIES



BA-0C
\$469

5.56 NATO



BA-AP416
\$524

5.56 NATO



BA-WCP
\$444

5.56 NATO



FTBL-LR-02F
\$729

5.56 NATO



204-BA-24
\$854

.204 RUGER



FTBL-LR-20F
\$699

.223 REM



FTBL-LR-02
\$664

.223 REM



BA-A3AS
\$499

5.56 NATO



FTBL-LR-03
\$614

.223 REM



FTBL-LPC
\$444

5.56 NATO



BA-A3AS-16
\$495

5.56 NATO



BA-3G1
\$885

5.56 NATO



BA-3G2

\$1239

5.56 NATO



BA-MSASS

\$1085

5.56 NATO



BA-16A3L

\$454

5.56 NATO



BA-LBR

\$569

5.56 NATO



FTBL-LR-20

\$634

.223 REM

BA-REC

\$659



5.56 NATO

BA-MWC

\$575



5.56 NATO

BA-TPR

\$699



5.56 NATO

BA-3G2

\$855



5.56 NATO

BA-TAC2

\$699



5.56 NATO

DPMS

UPPER RECEIVERS/ CHARGING HANDLES

FOR REFERENCE, PLEASE SEE PAGES 80-83 FOR A COMPLETE DIAGRAM OF MIL SPEC PARTS

A3 FLAT TOP RECEIVER / STRIPPED OR ASSEMBLED

Forged .223/5.56 mil-spec A3 upper receiver features integral Picatinny top rail for mounting detachable carry handle, sights, or optics. Assembled A3 upper receiver (FTT-EA1) includes charging handle, ejection port cover, and forward assist assembly (not included on stripped A3 upper receiver, P/N FTT-EA).



FTT-EA | \$125
STRIPPED

FTT-EA1 | \$165
ASSEMBLED (shown)

.308 A3 UPPER RECEIVER / .308 LITE A3 UPPER RECEIVER



308-FTT-EA | \$169.95
STRIPPED

308-FTT-EA1 | \$209.95
ASSEMBLED (shown)



308-FTT-LW | \$199.95
STRIPPED

308-FTT-LW1 | \$269.95
ASSEMBLED (shown)

DETACHABLE CARRYING HANDLES FOR A3 STYLE RECEIVERS



308-DCH | \$139.95
FOR .308 UPPER RECEIVERS



FT-DCH | \$89.95
FOR .223 / 5.56 UPPER RECEIVERS

A1 UPPER RECEIVER



A1 style fixed carry handle, forged from 7075 aluminum that has been T6 heat treated, hard coat anodized (Mil-A-8625A) and Teflon® coated Black / UR-A1 is assembled with the charging handle, shell deflector, dust cover, teardrop forward assist and A1 sight assembly (windage only)

UR-01-E3 | \$134.95 - STRIPPED (shown)

UR-A1 | \$199.95 - ASSEMBLED

A2 UPPER RECEIVER



A2 sight assembly, windage and elevation adjustable / Shell deflector, dust cover and forward assist / UR-01-A3B is assembled with charging handle, forward assist & ejection port cover assembly

UR-36 | \$99.95 - STRIPPED

UR-01-A3B | \$219

ASSEMBLED (shown)

.223/5.56 FLAT TOP LO-PRO RECEIVER



Dust cover omitted for lightweight, smooth, snag-free function
State-of-the-art aluminum material
Picatinny rail
No forward assist or ejection cover

FTT-LP | \$125

TAC LATCH CHARGING HANDLE ASSEMBLY



Replacement charging handle for use with AR-15/M-16 or SR-25 pattern rifles. Extended latch allows for improved functionality - a must for tactical and scoped flat top rifles.

CH-TL | \$43.95 .223/5.56mm

308-CH-TL | \$63.95 .308 WIN

TACTICAL LATCH



Extended charging handle latch for AR-15/M-16 or SR-25 pattern charging handles. Design allows for improved functionality - a must for tactical and scoped flat top rifles. Latch only - charging handle not included.

CL-T | \$19.95

SEE PAGES 80-83 FOR COMPLETE DIAGRAM OF MILSPEC REPLACEMENT PARTS

DPMS RIFLE BARRELS

4150 CHROME 1X9 7" BARREL



BL-50-12A
\$185

5.56 SASS 1X8 18" BARREL



BL-SASS
\$299.95

4150 HVY 1x9 CHROME 11" BARREL



BL-50-12B
\$185

.223 BULL SST 1X9 20" BARREL



(shown)
BULL-01
\$269
BULL-01-F (FLUTED)
\$299

5.56 SPORTICAL 16" BARREL



(shown)
BL-SPORTICAL
\$169
BL-SPORTICAL-S (STAINLESS)
\$199

.223 BULL SST 1X9 FLUTED 24" BARREL



BULL-01-24FL
\$344

5.56 DISSAPATOR 1X9 16" BARREL



BL-10-A
\$180

5.56 4150 1X9 CHROME AP4 16" BARREL



BL-50-AP4AX9C
\$221

.223 BULL SST 1X9 16" BARREL



BL-01-16
\$259

LITE 1X9 16" BARREL



BL-L16
\$169

5.56 MK12 1X8 18" BARREL



BL-M12-S
\$179

5.56 HVY 1X9 16" BARREL



BL-11
\$170

7.62X51 SPORTICAL LITE 16" BARREL



308-BL-SPORT
\$299.95

7.62X51 AP4 16" BARREL



308-BL-AP4
\$299.95

7.62x51 SASS 18" BARREL



308- BL-SASS
\$299.95

.308 BULL 24" BARREL



308-BL-24
\$299.95

.308 FLUTED BULL 24" BARREL



308-BL-24F
\$364.95

7.62x51 20" HVY BARREL



308-BL-20
\$299.95

.204 24" BARREL



204-BL-24
\$259.95

.260 BARREL 20" BARREL



260-BL-L20
\$299.95

.243 HUNTER 20" BARREL



243-BL-20GB
\$349.95

VISIT WWW.DPMSINC.COM FOR THOUSANDS MORE PARTS AND ACCESSORIES FROM DPMS AND YOUR OTHER FAVORITE BRANDS.

DPMS PARTS KITS/ ACCESSORIES

AR STYLE LOWER RECEIVER PARTS KIT

.308 LOWER RECEIVER PARTS KIT

DPMS™ TWO-STAGE

Includes the following lower receiver parts:

Pistol grip / trigger / hammer / disconnecter / selector bolt catch spring / detent spring / bolt catch buffer take down detent / bolt catch / magazine catch spring bolt catch roll pint / magazine catch button / magazine catch front pivot pin / hammer spring / trigger spring / pistol grip screw pistol grip lock washer / selector spring / detent selector hammer pin / trigger pin / take down pin / buffer retainer pin buffer retainer spring / disconnecter spring

LRPK-308

\$85.95 - single

LRPK-308B

\$84.95 - bagged



LRPK-1

\$66.95 - single

LRPK-1B

\$65.95 - bagged

LRPK-TS

\$149.95 - 2 stage trigger

TRIGGER GROUP



DPMS manufactured AND for ALL DPMS rifles. / Pull weight: 1st stage: 1 ¼ lbs. 2nd stage: 4 ½ lbs. / Uses your existing hammer and trigger pins / LR-22 and LR-32M are included.

TR-TS-D | \$99.95

LOWER RECEIVER PARTS KIT

A2 UPPER RECEIVER PARTS KIT

A3 UPPER RECEIVER PARTS KIT

AMBIDEXTROUS

WITHOUT HAMMER, TRIGGER, OR PISTOL GRIP

WITH CHARGING HANDLE

WITH CHARGING HANDLE

SELECTOR SWITCH



Includes all parts included in the AR style and M16 Lower Receiver Parts Kit, except hammer, trigger, and pistol grip. Will not work with .308 rifles.

LRPK-SP | \$44.95

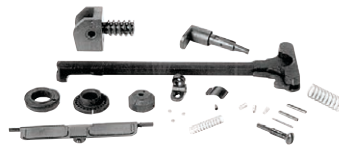

URPK-LCH | \$50 without charging handle

URPK-1 | \$68 with charging handle



URPK-1A3 | \$34.95



LR-08B | \$29.95

FIELD REPAIR KIT

DPMS™ PIN KIT

BOLT COMPONENT

DPMS™ SPRING KIT



Kit Includes: trigger spring / extractor extractor spring assembly / disconnecter spring / hammer spring / extractor pin firing pin retaining pin / firing pin ejector / spring / and ejector.

BP-01 | \$31.95



Kit includes: rear takedown pin / front pivot pin / firing pin / retaining pin / hammer pin / takedown detent / delect gas tube roll pin / trigger guard pin / bolt catch roll pin / forward assist pin / extractor pin / ejector roll pin / rear base spring / rear base spring pin.

BP-03 | \$20.95

TOOL KIT



Kit Includes: extractor / extractor spring / ejector roll pin / 3 gas rings ejector / extractor pin / and extractor spring assembly.













BP-02 | \$23.95



Kit Includes: Rear base elevation knob spring / ejection port cover spring / hammer spring / forward assist spring / trigger spring / magazine catch spring / front sight spring / selector spring / disconnecter spring / bolt catch spring / extractor spring / detent spring.

BP-04 | \$15.95

DPMS CLAMSHELLS

<p>A2 BUTTSTOCK KIT</p>  <p>Trap door assembly / A2 buttplate / swivel / hinge / hinge pin / std. A2 buttstock shell / A2 upper - lower screw / standard recoil spring / standard buffer / extension tube / aluminum spacer</p> <p>BP-27 \$94.95</p>	<p>AP4 BUTTSTOCK KIT</p>  <p>AP4 carbine stock body / extension tube / buffer spring / buffer / latch plate / lock ring</p> <p>BP-28 \$94.95</p>	<p>.308 AP4 BUTTSTOCK KIT</p>  <p>AP4 carbine stock body / extension tube / .308 buffer spring / .308 buffer / latch plate / lock ring</p> <p>308-BP-28 \$99.95</p>	<p>PARDUS BUTTSTOCK KIT</p>  <p>Pardus carbine stock / extension tube / buffer spring / buffer / latch plate / lock ring</p> <p>BP-29 \$62.95</p>
<p>DELTA PAK</p>  <p>BL-08 barrel spring / BL-07 barrel snap ring / BL-09 Delta ring</p> <p>BP-06 \$13.95</p>	<p>BUTTSTOCK EXTENDER</p>  <p>Exposed spacer / internal spacer / two longer stock retaining screws for A1 or A2 rifles</p> <p>BP-14 \$32.49</p>	<p>A-15 FIRE CONTROL KIT</p>  <p>A-15 trigger / hammer / disconnecter / selector.</p> <p>BP-05 \$52.49</p>	<p>NM SIGHT KIT</p>  <p>FS-03 detent / FS-04 spring / FS-NM front sight / TL-A2 front sight tool.</p> <p>BP-NM \$16.49</p>
<p>A1 SIGHT KIT</p>  <p>FS-03 detent / FS-04 spring / FS-02 front sight / TL-A1 front sight tool.</p> <p>BP-A1 \$9.49</p>	<p>A1 SIGHT TOOL</p>  <p>Product will arrive in a sealed shell: steel, 5-prong a1 front & rear sight adjusting tool</p> <p>TL-A1 \$8.49</p>	<p>A2 SIGHT KIT</p>  <p>FS-03 detent / FS-04 spring / FS-02 front sight / TL-A2 front sight tool.</p> <p>BP-A2 \$9.49</p>	<p>A2 SIGHT TOOL</p>  <p>Product will arrive in a sealed shell: steel, 4-prong a2 front & rear sight adjusting tool</p> <p>BP-25 \$9.49</p>

DPMS™ ULTIMATE REPAIR KIT



BP-26 | \$56.95 - sealed shell
FR-UK | \$51.95 - poly bag

A15 Disconnecter / front pivot pin, takedown pin / extractor / 3 gas rings / firing pin retaining pin / detent (selector) / takedown detents / trigger pin / hammer pin / hammer spring / trigger spring / AR firing pin / extractor pin / gas tube roll pin / ejector roll pin / rear base spring pin / trigger guard pin / bolt catch / release pin / buffer retainer spring / selector spring / bolt catch / spring / detent spring / ejector port cover spring / front sight / spring / ejector spring / extractor spring assembly / disconnecter spring / detent spring / / magazine catch spring.

DPMS GAS BLOCK/ GAS SYSTEMS

SINGLE RAIL GAS BLOCK

.750 DIA. OR .936 DIA.



Single rail gas block .750 dia. or .936 dia.
Picatinny rail on top of gas block.

GB-SR7 | \$49.99

GB-SR9 | \$49.99

4-RAIL GAS BLOCK



GB-4RA | \$49.95 - .750" dia.

GB-4R | \$49.95 - .936" dia.

ALUMINUM GAS BLOCK



BULL-02-ST | \$29.95 - .750" dia.

BULL-02 | \$29.95 - .936" dia

GB HUNTER GAS BLOCK



.750 diameter, low-profile gas block

GB-HUNTER | \$29.95

DPMS™ .308 SINGLE RAIL

GAS BLOCKS



308-GB-SR7 | \$69.95 - .750" dia.

308-GB-SR9 | \$69.95 - .936" dia.

DPMS™ MICRO

GAS BLOCKS



GB-LP750 | \$19.95 - .750" dia.

GB-LP936 | \$19.95 - .936" dia.

DPMS™ AR-15 STYLE

GAS SYSTEM KITS



Gas System Kit includes: 1 Gas tube
roll pin / 1 standard length gas tube
/ 3 bolt gas rings / 2 bolt carrier key
screws / 1 bolt carrier key.

GS-KT - STD | \$30.95

GS-KTC - CARBINE | \$30.95

DPMS

AR FREE-FLOAT TUBES / HANDGUARDS

CARBON FIBER FREE-FLOAT TUBES

STANDARD & CARBINE

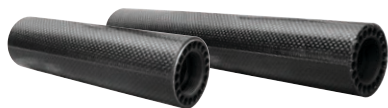

The 2" diameter carbon fiber free-float handguards from DPMS stay cooler than the standard aluminum free-float tubes and weigh less, 40% less, providing you with a unique alternative to the traditional handguard. The carbon fiber utilized in these free-float tubes works in two ways: internally the unidirectional carbon fiber increases the strength and stability of the tube while externally the bi-directional carbon fiber provides a textured look and feel.

FF-CF I \$99.00 - standard length

FF-CFC I \$89.00 - carbine length

BASIC FREE-FLOAT TUBES

STANDARD & CARBINE



FF-01 I \$49.95 - carbine length

FF-02 I \$53.95 - standard length

4-RAIL FREE-FLOAT TUBES

STANDARD, CARBINE & KITTY KAT



The improved version of the 4-rail free-float tube features a solid one-piece free-float tube made from 6000 Series aluminum with a T6 heat treatment. The Picatinny style rails are integrally machined into the free-float tube. The Picatinny rails are designed for the attachment of foregrips, flashlights, optics or any other type of rail-mounted accessories. The tube is also vented with 16 individual vents for increased airflow to the barrel.

FF-4RK I \$129.95 - kitty kat

FF-4R I \$134.00 - carbine

FF-ST4 I \$149.00 - standard

KITTY KAT FREE-FLOAT

TUBE



For Kitty Kat 7.5" barrels only.

FF-03 I \$53.00

VENTED FREE-FLOAT TUBES

STANDARD & CARBINE



FF-01VCAR I \$74.95 - carbine length

FF-02VSTD I \$78.95 - standard length

2-PIECE HANDGUARD



BL-01M I \$27.95 - standard length

BL-02 I \$19.95 - carbine length

DPMS AR FREE-FLOAT TUBES / HANDGUARDS

DPMS™ M111 MODULAR HANDGUARD SYSTEM







The M111 is a modular, lightweight, free-float handguard designed for use with .223/5.56 or .308 AR-pattern rifles. Machined from 6061 aluminum alloy, the M111 features threaded steel inserts around the handguard to allow secure attachment of Picatinny rail sections for a wide range of accessory mounting options. Offered in 3 lengths, each M111 comes with two (2) short and one (1) long Picatinny rail section. All mounting hardware included.

AVAILABLE IN
THESE CALIBERS:



FF-M111-C3 | \$237.95 - Carbine-Length M111 Handguard for .223/5.56 Rifles
FF-M111-M3 | \$237.95 - Mid-Length M111 Handguard for .223/5.56 Rifles
FF-M111-S3 | \$237.95 - Rifle-Length M111 Handguard for .223/5.56 Rifles

M111-FF-C3 | \$247.95 - Carbine-Length M111 Handguard for .308 Rifles
M111-FF-M3 | \$247.95 - Mid-Length M111 Handguard for .308 Rifles
M111-FF-S3 | \$247.95 - Rifle-Length M111 Handguard for .308 Rifles

2 PC. FREE-FLOAT FOREARM MID-LENGTH	2 PC. FOREARM EXTENDED CARBINE LENGTH	2 PC. FOREARM MID & CARBINE LENGTH	ERGO Z-RAIL™ 2-PIECE HANDGUARD
			
FF-MCTAR21 \$224.95	HG-MCTAR17X \$179.00	HG-MCTAR18 \$167.50	HG-4811 \$149.95

YANKEE HILL™ HANDGUARDS FULL, MID, & CARBINE LENGTH	TROY INDUSTRIES™ CARBINE DROP-IN RAIL	TAPCO INTRAFUSE CARBINE HANDGUARD
		
HG-YHM-9803 \$197.00 - full HG-YHM-9670 \$147 - carbine	HG-DBR7-BLK \$149.00	HG-STK093-B \$59.95

DPMS

.308 FREE-FLOAT TUBES / HANDGUARDS

4-RAIL FREE-FLOAT TUBES

FOR LR-308 RIFLES



The .308 cal. version of the 4-rail free-float tube features a solid one-piece free-float tube made from 6066-T6 aluminum. The Picatinny style rails are integrally machined into the free-float tube. Two rail heights are available, one for the A3-style upper receiver and the other for the original LR-308 upper receiver. Each rail height is available in two lengths, standard and carbine. The free-float tubes are vented and hard coat anodized per Mil Spec and matte black in color. Overall width dimension is 2.1," only slightly wider than the AR-style free-float tubes and include a manganese phosphated steel locking collar to control the timing of the rails.

308-FF-4CH I \$179.95 **308-FF-4SL I** \$189.95
308-FF-4SH I \$189.95 **308-FF-4MID I** \$179.95
308-FF-4CL I \$179.95

.308 FREE-FLOAT TUBES VENTED



308-FF-02VSTD I \$79.95 standard length
308-FF-01VCAR I \$79.95 carbine length

.308 CARBON FIBER

FREE-FLOAT TUBES

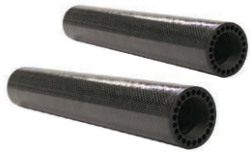

The 2.1" diameter .308 caliber carbon fiber free-float handguards from DPMS stay cooler than the standard aluminum free-float tubes and weigh less, providing you with a unique alternative to the traditional handguard. The carbon fiber utilized in these free-float tubes works in two ways: internally the unidirectional carbon fiber increases the strength and stability of the tube while externally the bi-directional carbon fiber provides a textured look and feel to the free-float tube. Additionally, an internal layer of fiberglass prevents corrosion between the aluminum tube and the carbon fiber, ensuring a long-lasting lightweight alternative tube. Includes the hard, anodized barrel nut.

308-FF-CF I \$133.95 - standard length
308-FF-CFC I \$133.95 - carbine length

.308 FREE-FLOAT TUBES STD.



308-FF-02 I \$59.95 standard length
308-FF-01 I \$59.95 carbine length









DPMS™ LRT-SASS QUAD RAIL

HANDGUARD







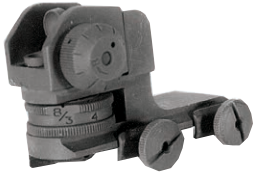

308-FF-SASS I \$229.95

DPMS FRONT SIGHTS

NATIONAL MATCH A1	NATIONAL MATCH A2	EXT. FRONT
FRONT POST	SIGHT POST	POST-SQUARE
 <p>NM-FS \$12.95</p>	 <p>FS-DCM \$12.95</p>	 <p>FS-08 \$14.95</p>
TROY INDUSTRIES™	TROY INDUSTRIES™	TROY INDUSTRIES™
GAS BLOCK SIGHT	FRONT HK BUIS	HK GAS BLOCK SIGHT
 <p>FS-GBF-BK \$129.00</p>	<p>for forearm</p>  <p>FS-FHKBS-BLK \$99</p>	 <p>FS-GBFHK-BK \$129.00</p>
HI-VIZ AR-15 STYLE	DETACHABLE FRONT	
FRONT SIGHT	SIGHT BASE	
 <p>FS-HIVIZ \$31.49</p>	 <p>FS-DET-S \$54.95</p>	

DPMS REAR SIGHTS/ PARTS/TOOLS

NM REAR APERTURES	DETACHABLE 6/3 A2 REAR SIGHT	A1/A2 FRONT SIGHT
 <p>\$14.95/each UR-27-NM - .046/.200 dia. UR-27A-NM - .052/.200 dia. UR-27B-NM - .040/.030 dia.</p>	 <p>FT-RS \$79.95</p>	<p>POST TOOL</p>  <p>TL-9942 \$9.95</p>
RAPIDEX KNOB	A2 SIGHT ADJUSTING TOOL	A1 SIGHT ADJUSTING TOOL
 <p>Replaces A1 Rear Sight Windage Drum</p> <p>UR-39A1 \$9.00</p>	 <p>TL-A2 \$8.49</p>	 <p>TL-A1 \$8.49</p>
A1 REAR SIGHT ASSEMBLY	A2 REAR SIGHT ASSEMBLY	
 <p>UR-21A \$15.00</p>	 <p>UR-21 \$38.00</p>	

DPMS

MUZZLE BRAKES / COMPENSATORS

<p>.308 PANTHER FLASH HIDER</p>  <p>Precision-machined, phosphate-coated. This suppressor eliminates flash. Excellent performance. Made for the .308 Rifles. 308-BL-YH \$44.95</p>	<p>PANTHER COMPENSATOR</p>  <p>Modified A2 Compensator. Gasses are diverted through two sets of five holes in upper sides of compensator. 308-BL-TP \$25.00</p>	<p>DPMS™ PANTHER COMPENSATOR</p>  <p>Modified A2 Compensator. Muzzle rise is dampened by three slots and four holes across the top of the compensator. BL-06D \$21.95</p>
<p>BRANSON COMPENSATOR</p>  <p>Replacement for the A-15/EM-16 with no vents on the bottom. Gives better control and less dust and dirt blown up by the muzzle blast. BL-21 \$29.95</p>	<p>AAC 7.62 / .308 SG FLASH HIDER</p>  <p>3-prong spring loaded flash hider designed for AAC's 7.62 SG Suppressor. 308-BL-762SG \$99.95</p>	<p>AAC .308 MUZZLE BRAKE</p>  <p>Ratchet style muzzle brake designed for AAC's silencers. 308-BL-NB02 \$149.95</p>
<p>AAC 5/8 X 24 TPI THREAD PROTECTOR</p>  <p>For use with any 5 /8 x 24 .308 barrel. 308-BL-TP \$25.00</p>		

<p>.308 A2 COMPENSATOR</p>  <p>No slots on bottom, Crush Washer required. 5/8 - 24 Threads. 308-BL-06-A2 \$29.95</p>	<p>A2 COMPENSATOR FOR .223 / 5.56 RIFLES</p>  <p>No slots on bottom. 1/2 - 28 Threads. BL-06-A2 \$8.00</p>	<p>PANTHER FLASH HIDER</p>  <p>Precision-machined, phosphate-coated. This flash hider eliminates muzzle flash. Threaded 1.2 x 28 for .223/5.56mm. BL-YH \$24.95</p>
<p>AAC 5.56 M4 2000 FLASH HIDER</p>  <p>BL-FH-M42000 \$99.95</p>	<p>AAC 5.56 MUZZLE BRAKE</p>  <p>BL-NB01 \$149.95</p>	<p>A1 FLASH HIDER</p>  <p>BL-05-A1 \$8.00</p>
<p>3 PRONG FLASH HIDER</p>  <p>BL-3P \$9.95</p>	<p>BLACKOUT® NON-MOUNT 5.56 FLASH HIDER</p>  <p>Slides over the A-15 Compensator. Protects bore from the elements. 308-BL-NB02 \$149.95</p>	<p>5.5" FLASH HIDERS</p>  <p>BL-20 5 1/2" Flash Hider (used on Carbine or other threaded barrels) / BL-20A Flash Hider slides over 16" barrel to give it the appearance of a carbine barrel. Fits pre-ban threaded barrels only. BL-20 \$19.95 BL-20A \$19.95</p>

DPMS BOLTS / PINS / OFFSET PARTS

FOR REFERENCE, PLEASE SEE PAGES 80-83 FOR A COMPLETE DIAGRAM OF MIL SPEC PARTS

A-15 QUICK TAKEDOWN PIN	6.8MM EXTRACTOR ASSEMBLY	6.8MM BOLT ASSEMBLY	6.8MM BOLT CARRIER ASSEMBLY	DPMS WEDGE
				
LR-QT-S \$7.00	BT-68E \$23.95	BT-68 \$79.95 BT-68S \$52.95	BCBA-68AS \$165.90	DPMS Wedge fits in rear of lower and buffers cycling system to reduce wear. ACU-01 \$5.95
NON-ROTATIONAL TRIGGER GROUP PINS	FIRING PIN RETAINING PIN	STAINLESS STEEL TRIGGER GROUP PINS	PUSH BUTTON TAKE DOWN PIN	OFFSET SCREW & NUT
				
LR-KNS-2 \$32.95 - .154 dia. LR-KNS-3 \$32.95 - .170 dia.	KNS CNC Machined Steel Firing Pin Retaining Pin. Guaranteed Forever by KNS! BT-KNS16 \$7.95	KNS Stainless Steel Trigger Group Pins. LR-KNS-4 \$5.95	LR-KNS-250TD \$16.95	LR-0SN \$3.00
A-15 ANTI-WALK PINS	A-15 BOLT CARRIER EXTENDED	EXTENDED TAKEDOWN PIN	OFFSET BUSHING	OVERSIZED TAPER PIN
				
LR-AW \$5.00/per set	BT-13 \$55.00	LR-30ETP \$9.95	Adapts large hole Colt uppers front pivot pin diameter to small hole lowers pin diameter. LR-0B \$3.00	Oversize front sight taper pin for re-aligning and replacing front sight bases. FS-06L \$0.95
PIVOT PIN WITH SLING STUD	PUSH BUTTON PIVOT PINS	OFFSET SCREW/NUT		
				
LR-KNS-6 \$14.95 .250 dia.	LR-KNS-7 \$14.95 .315 Dia.	LR-KNS-250PP \$16.95 .250 dia.	LR-KNS-315PP \$16.95 .315 dia.	LR-0S2 \$8.95

DPMS MAGAZINES/ ACCESSORIES

<p>.308 MAGAZINE 4-ROUND</p>	<p>.308 MAGAZINE 10-ROUND</p>	<p>.308 MAGAZINE 20-ROUND</p>
 <p>For use with .243, .260, .308, and 6.5 calibers</p> <p>MA-3084 \$44.95</p>	 <p>For use with .243, .260, .308, .338, and 6.5 calibers</p> <p>MA-3081 \$44.95</p>	 <p>For use with .243, .260, .308, .338, and 6.5 calibers</p> <p>MA-3082 \$44.95</p>
<p>AR-15 MAGAZINE 20-ROUND MIL-SPEC - GREY</p>	<p>AR-15 MAGAZINE 20-ROUND - CURVED</p>	<p>AR-15 MAGAZINE 30-ROUND MIL-SPEC - BLACK</p>
 <p>MA-08 \$19.95 - straight</p>	 <p>MA-20 \$19.95 - curved</p>	 <p>MA-02 \$19.95</p>
<p>AR-15 MAGAZINE 30-ROUND CURVED - GREY DRY FILM</p>	<p>DPMS™ TACTICAL BOLT CATCH</p>	<p>10 ROUND A-15 MAG</p>
 <p>MA-02L \$19.95</p>	 <p>LR-11T \$13.95</p>	 <p>Constructed from polymer that is strong due to its waffle design.</p> <p>MA-PP \$19.95</p>
<p>10 ROUND ALUMINUM MAG</p>		
 <p>MA-10 \$24.95</p>		

TO SEE MORE OF OUR MAGAZINES AND ACCESSORIES,
PLEASE VISIT US ONLINE: WWW.DPMSINC.COM







DPMS BUTTSTOCKS/ ACCESSORIES

FOR REFERENCE, PLEASE SEE PAGES 80-83 FOR A COMPLETE DIAGRAM OF MIL SPEC PARTS

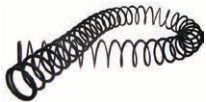











AP4 CARBINE STOCK	PARDUS CARBINE STOCK	A2 ASSEMBLIES
<p>ASSEMBLY</p>  <p>Lightweight, fiber reinforced black Zytel, black matte finish. Built-in swivel.</p> <ul style="list-style-type: none"> • 6 position locking • Aluminum extension tube • Rear slot for sling <p>308-CS-AP4 \$99.95 - for .308 CS-AP4 \$94.95</p> <p>ATTENTION: The pre ban configuration of the carbine stock assembly pictured above, as well as others on this page, may not be legal in your state. Please check with your local officials.</p>	<p>ASSEMBLY</p>  <p>CS-PS \$62.95 308-CS-PS \$69.95 - for .308</p>	 <p>Full LR-308 and AR-15 Caliber Buttstock Assembly</p> <p>308-BS-10 \$104.95 BS-10 \$94.95</p>
<p>A2 BUTTSTOCK 1" EXTENDER</p>  <p>Adds a full 1" to buttstock</p> <p>BS-20 \$29.95</p>	<p>MIL-SPEC AR-15 CARBINE BUFFER TUBE ASSEMBLY</p>  <p>CS-09-DOD-A \$61.90</p>	<p>BUTTSTOCK EXTENSION TUBE</p>  <p>BS-09 \$19.95</p>

DPMS BUTTSTOCKS/ ACCESSORIES

FOR REFERENCE, PLEASE SEE PAGES 80-83 FOR A COMPLETE DIAGRAM OF MIL SPEC PARTS

TUBBS SILICON FLAT	COMMERCIAL SIZE CARBINE	6-POSITION BUFFER TUBE
<p data-bbox="63 479 235 502">BUFFER SPRING</p>  <p data-bbox="63 730 494 797">Extended life at optimum performance. Lasts for approx. 5000 rounds before its performance has degraded to the point that rifle function will change.</p> <p data-bbox="63 846 308 869">BS-ARBUF \$24.95 - for 5.56</p>	<p data-bbox="509 479 786 502">BUFFER TUBE ASSEMBLY</p>  <p data-bbox="509 817 793 869">CS-09-AP4-A1 \$46.90 308-CS-09-A1 \$56.95 - for .308</p>	<p data-bbox="964 479 1298 502">6-POSITION BUFFER TUBE</p> <p data-bbox="964 508 1148 531">(MILITARY DIA.)</p>  <p data-bbox="964 817 1285 869">CS-09-000 \$34.95 CS-09-AP4 \$19.95 - commercial tube</p>
<p data-bbox="63 904 251 927">STOCK BUFFER</p> <p data-bbox="63 942 378 966">STANDARD & CARBINE LENGTH</p>  <p data-bbox="63 1143 462 1224">308-BS-11 \$29.95 std. length BS-11 \$18.95 A-15 std. length 308-CS-10B \$24.95 carbine length BS-11A \$15.00 A-15 carbine length</p>	<p data-bbox="509 904 739 927">BUFFER SPRINGS</p> <p data-bbox="509 942 847 966">STANDARD & CARBINE LENGTH</p>  <p data-bbox="509 1143 916 1224">308-BS-10B \$9.95 std. length BS-10B \$4.95 std. length 308-CS-10A \$5.39 carbine length BS-10A \$4.95 carbine length</p>	<p data-bbox="964 904 1148 927">A1 BUTTPLATE</p>  <p data-bbox="964 1188 1108 1211">BS-02A \$3.50</p> <ul data-bbox="1162 1143 1362 1211" style="list-style-type: none"> • Smooth face buttplate • No checkering • Fits A2 buttstocks



DPMS RIFLE SLING ACCESSORIES

AMBI STOCK	CARBINE STOCK	FRONT SIGHT	6-POSITION REAR
SLING ADAPTER	SLING ADAPTER - RIGHT	SLING ADAPTER	SLING ADAPTER
			
CS-ADP \$14.95	CS-ADPR \$14.95	FS-SM \$39.95	SL-MCTAR10 \$39.99
SLING ADAPTER	END PLATE	A2 STOCK	4-POSITION REAR
	ADAPTER	SLING ADAPTER	SLING ADAPTER
			
SL-MCTAR06 \$33.70 SL-MCTAR07 \$23.20 - with stud	SL-MCTAR13 \$35.35 - loop SL-MCTAR14 \$35.95 - slot	BS-ADP \$39.95	SL-MCTAR09 \$39.99
DETACHABLE	QUICK DETACH	MI QUICK DETACH	CARBINE STOCK
SLING SWIVEL	SLING SWIVEL	SWING SWIVEL	SWIVEL STUD
		heavy duty	
			
BL-DTS \$20.00	SL-MCTAR08 \$33.72	SL-MCTAR08HD \$35.95	CS-SS \$9.95

DPMS ARMORER'S TOOLS

<p>DPMS™ FLIPPER</p>  <p>"The Flipper", made of Delrin, is a versatile armorer's tool. Clamp into your vise and it holds any A-15 / EM-16 or .30 caliber lower receiver for assembly purposes. Will not work with the LR-308 line of upper receivers / receiver assemblies.</p> <p>308-MA-FP \$45.95 MA-FP \$35.95</p>	<p>DPMS™ PANTHER CLAW</p>  <p>The Panther Claw is the perfect armorer's tool for holding all AR style uppers. Made of a solid one-piece high strength polymer, the Claw is extremely durable. Makes installing barrels a breeze!</p> <p>308-TL-PRC \$60.95 TL-PRC \$50.95</p>	<p>DPMS™ PUNCH KIT</p> <p>WITH 2 HAMMERS</p>  <p>Professional gunsmith punch and hammer set in a hard plastic case. Includes: Brass hammer with steel knurled shaft, Nylon hammer, 8 brass punches, 2 Delrin Punches, and 2 steel punches.</p> <p>TL-PHK \$39.95</p>	<p>DPMS™ ARMORER'S TOOL KIT</p>  <p>Designed by our armorers, this kit is a complete tool kit for anyone with AR-type rifles. All the tools you need to handle any task for the serious gunsmith to the average shooter.</p> <p>TL-AKT \$229.95</p>
<p>G&G BOLT FACE</p> <p>CLEANER / POLISHER</p>  <p>Fits in one hand for ease of use, while the pivot arm allows plenty of torque for superior cleaning. The unique polisher ensures the carbon is removed and helps prevent residual build-up on the bolt tail.</p> <p>CK-BC \$39.95</p>	<p>DPMS™ A-15 BARREL</p> <p>WISE JAWS</p>  <p>Vise Jaw with "V" blocks for other assembly work. Designed specifically for 1" Bull barrels and 3/4" heavy barrels.</p> <p>TL-05 \$24.95</p>	<p>MILITARY PUNCH SET</p>  <p>Great for home repair and sight adjustment. Contains 1 each of the following. Steel: 1/16", 3/32" and Brass: 1/8", 3/32", 3/16", 7/32", 1/4", 9/32", 5/16"</p> <p>TL-08 \$18.95</p>	<p>FREE-FLOAT INSTALLATION</p> <p>WRENCH</p>  <p>Used to install most free-float tubes to upper. Made from steel plate with two wrenching pins. AR-style rifles only.</p> <p>FF-W1 \$25.95</p>
<p>BARREL EXTENSION</p> <p>WRENCH</p>  <p>TL-BX \$58.95 - .223 / 5.56 x 45mm TL-BX1 \$68.95 - .308 Caliber</p>	<p>CAR STOCK NUT</p> <p>WRENCH</p>  <p>Car stock nut wrench. Manufactured by DPMS. This car stock nut wrench won't break the second time you use it!</p> <p>TL-CAR \$30.95</p>	<p>COMBINATION</p> <p>WRENCH</p>  <p>Removes barrel nut, extension tube, and flash suppressor.</p> <p>TL-02 \$16.95</p>	<p>DPMS™ AR MULTI-TOOL</p>  <p>Installs and disassembles:</p> <ul style="list-style-type: none"> • Free-float tubes • Barrel nut • Compensator • Barrel Extension Tube • Carbine Stock • 1/2" dive for socket wrench • Screw driver tip for buttstock screw • Hole for hanging on wall • 4140 Steel, mag phosphated <p>TL-MW \$34.95</p>

DPMS ARMORER'S TOOLS

LR-308/AR-10 FREE-FLOAT	CAR SPANNER/BUSHING	DELRIN PUNCH
WRENCH	WRENCH FOR A-15/.45	
 <p>LR-308/AR-10 Free-Float Wrench. Used to install most free float tubes to upper.</p> <p>308-TL-01 \$56.95</p>	 <p>CS-15/45 \$5.95</p>	 <p>Hard plastic tapered punch that can be used to drive out the front and rear pivot pins. Will not scratch or mar pins or receiver.</p> <p>TL-PU \$3.49</p>
BORE GUIDE W/ BARREL	SHELL EXTRACTORS	A-15/EM-16 HANDGUARD
EXTENSION LOCK-UP		REMOVAL TOOL
 <p>Locks into barrel extension to prevent movement of bore guide. Won't damage barrel or receiver.</p> <p>FS-MI-FST \$155.95</p>	 <ul style="list-style-type: none"> • .223 broken shell extractor, steel construction • .308 broken shell extractor, steel construction <p>TL-SE \$9.95 308-TL-SE \$9.95</p>	 <p>This tool gives you the leverage needed to compress the delta ring assembly, and allows the handguards to be easily removed as well as giving you easy access to the gas tube.</p> <p>TL-HGR \$12.95</p>
CARBON SCRAPER	TAPCO® HANDGUARD	
REMOVAL TOOL	REMOVAL TOOL	
 <p>Durable steel scraper removes carbon buildup in AR-15 style / M16 bolt carriers quickly and easily. Insert a section of your cleaning rod into the 7/32" hole to act as a T-Handle and turn; dual scraping edges clean in both directions.</p> <p>TL-6882 \$19.95</p>	 <p>This tool is a necessity for any AR shooter or agency armorer. It eases the removal of the handguards on both carbines and full-sized rifles. To prevent damage to the finish of the rifle, all areas that contact the weapon are covered with surgical plastic.</p> <p>TL-0901 \$15.95</p>	

DPMS RIFLE KITS

ORACLE 5.56 RIFLE KIT

LESS LOWER RECEIVER



KT-OC | \$599

SPORTICAL RIFLE KIT

LESS LOWER RECEIVER



KT-SPORT | \$574

LITE 16" A3 RIFLE KIT

LESS LOWER RECEIVER



KTA3-L16 | \$599

AP4 CARBINE RIFLE KIT

LESS LOWER RECEIVER



KT-AP4-LL | \$659

DPMS

MIL SPEC REPLACEMENT PARTS

A2 UPPER RECEIVER REPLACEMENT PARTS

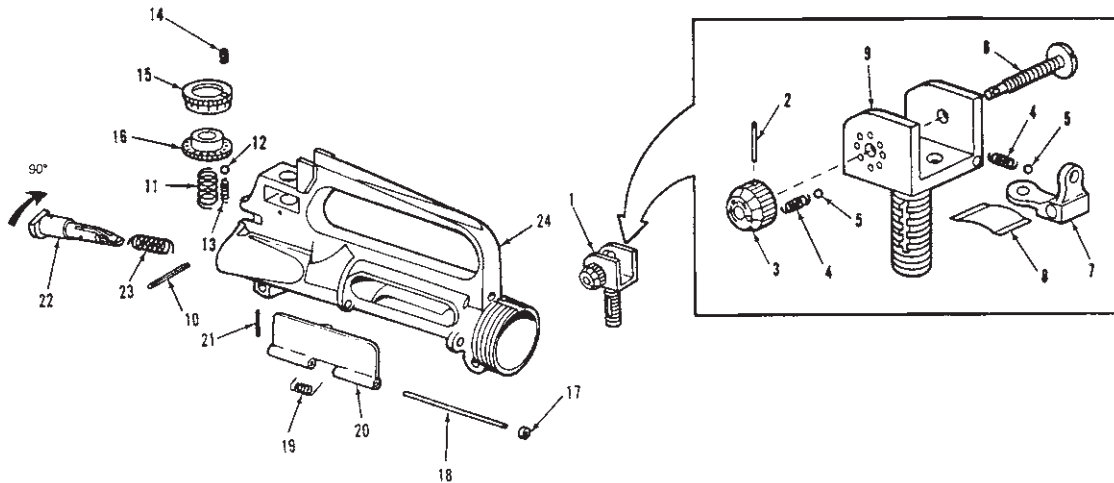

1	UR-21	Rear Base Sight Assembly A2 (Includes : Items 2-15 & 16)	\$38.00
2	UR-22	Rear Base Spring Pin	\$.75
3	UR-23	Rear Base Windage Knob	\$ 6.00
4	UR-24	Rear Base Spring (3 Required)	\$.75 ea.
5	UR-25	Rear Base Ball Bearing (3 Required)	\$.50 ea.
6	UR-26	Rear Base Windage Knob Screw	\$ 4.00
7	UR-27	Rear Base Aperture, A2	\$ 9.00
8	UR-28	Rear Base Flat Spring, A2	\$ 1.00
9	UR-29	Rear Base Lug, A2	\$ 18.95
10	UR-06	Forward Assist/ Rear Base Spring Pin	\$.75 ea.
11	UR-31	Rear Base Elevation Knob Spring	\$ 1.00
12	UR-25	Rear Base Ball Bearing (3 Required)	\$.50 ea.
13	UR-24	Rear Base Spring (3 Required)	\$.75 ea.

14	UR-32	Rear Base Index Screw, A2	\$2.00
15	UR-33	Rear Base Index Elevation	\$6.00
15A	UR-33A	6/3 Elevation Index Knob	\$6.95
16	UR-34	Rear Base Elevation Knob	\$6.00
17	UR-02	Ejection Hinge Pin Snap Ring	\$.50
18	UR-03	Ejection Port Cover Pin	\$1.50
19	UR-05	Ejection Port Cover Spring	\$.75
20	UR-04	Ejection Port Cover	\$5.75
20A	UR-05A	Ejection Cover Assembly	\$8.00
21	UR-06	Forward Assist/ Rear Base Spring Pin	\$.75
22	UR-08-RA	Forward Assist, Round	\$13.95
22A	UR-08-R	Forward Assist Assembly, Round (Includes UR-06, UR-07 & UR-08-RA)	\$14.95
23	UR-07	Forward Assist Spring	\$.75
24	UR-36	Receiver, Upper A2 (Black Teflon)	\$ 99.95



DPMS

MIL SPEC REPLACEMENT PARTS

A2 UPPER ASSEMBLY REPLACEMENT PARTS

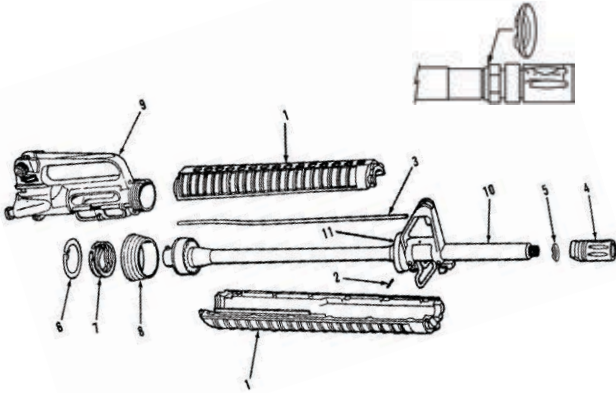

1A	BL-01M	Handguard Assembly, Mil-Spec	\$27.95
1B	BL-02	Carbine Handguards w/ Liners	\$19.95
2	BL-03	Gas Tube Roll Pin	\$.25
3	BL-04	Gas Tube, Std	\$15.00
3A	BL-04A	Gas Tube, Car.	\$15.00
3B	BL-04B	Gas Tube, 7" Length	\$15.00
3C	BL-04C	Gas Tube, Mid.	\$15.00
4	BL-06-A2	Compensator, A2	\$8.00
4	BL-05-A1	Compensator, A1	\$8.00
5	BL-06-PW	Peel Washer	\$2.49
5A	BL-06-LW	Compensator Lock Washer, A1	\$.53
5B	BL-06-CW	Crush Washer	\$2.99
6	BL-07	Barrel Snap Ring	\$1.50
7	BL-08	Weld Spring	\$5.00
8	BL-09	Delta Ring, Mil-Spec Aluminum (not plastic)	\$7.00
8A	BL-09D	Delta Pack (includes BL-07, BL-08 and BL-09)	\$12.95
9B	UR-01-A2B	A2 Upper Receiver, Black, unassembled	\$175.00
9D	UR-01-A3B	A2 Upper Receiver, Black, assembled	\$219.00
10	BL-10	Barrel 20"	\$179.00
	BL-11	Barrel 16"	\$170.00
	BL-12	Barrel 16", Carbine	\$185.00
	BL-11-AP4	Barrel 16", AP4 Contour	\$189.00
11	BL-19	Handguard Caps, Round	\$4.00
	BL-19A	Handguard Caps, Triangular	\$4.00

A1 UPPER ASSEMBLY REPLACEMENT PARTS

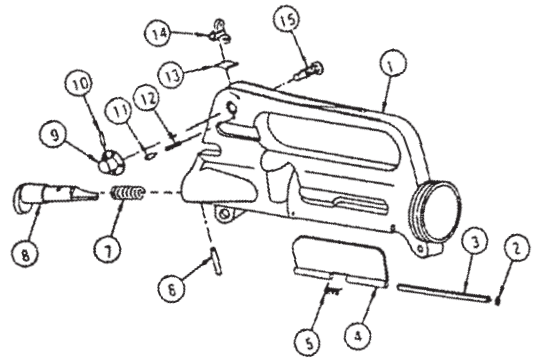

1A	UR-01-E3	Receiver, Upper A1, Black	\$134.95
2	UR-02	Ejection Hinge Pin Snap Ring	\$.50
3	UR-03	Ejection Port Cover Pin	\$1.50
4	UR-04	Ejection Port Cover	\$5.75
5	UR-05	Ejection Port Cover Spring	\$.75
	UR-05A	Ejection Cover Assembly	\$8.00
6	UR-06	Forward Assist Pin	\$.75
7	UR-07	Forward Assist Spring	\$.75
8	UR-08-TA	Forward Assist Only, Tear Drop	\$13.95
8A	UR-08-T	Forward Assist Assembly, Tear Drop (Includes UR-06, UR-07 and UR-08-TA)	\$14.95
9	UR-09-E3	Rear Sight Windage Drum, A1	\$4.00
10	UR-16	Rear Base Spring Pin, A1	\$.50
11	UR-11-E3	Rear Sight Detent, A1	\$.80
12	UR-12-E3	Rear Sight Detent Spring, A1	\$.75
13	UR-28	Rear Sight Flat Spring	\$1.00
14	UR-13-E3	Rear Sight Aperture, A1	\$9.00
15	UR-14-E3	Rear Sight Windage Screw, A1	\$5.00

DPMS MIL SPEC REPLACEMENT PARTS

LOWER ASSEMBLY

REPLACEMENT PARTS

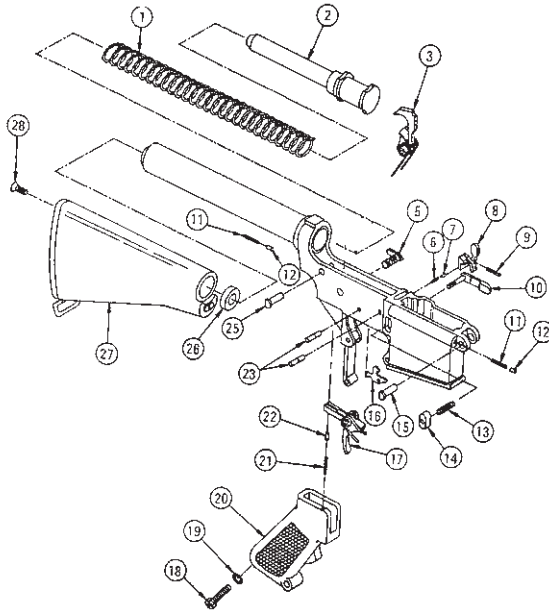

1	BS-10B	Buttstock Buffer Spring, Std.	\$4.95
1A	BS-10A	Buttstock Buffer Spring, Car. (not shown)	\$4.95
2	BS-11	Buffer Body Assembly, Std.	\$18.95
2A	BS-11A	Buffer Body Assembly, Car. (not shown)	\$15.00
3	LR-32/33	Hammer A-15 w/Spring	\$22.49
5	LR-08	Selector A-15	\$9.00
6	LR-09	Bolt Catch Spring	\$.75
7	LR-10	Bolt Catch Buffer	\$2.00
8	LR-11	Bolt Catch	\$9.00
9	LR-12	Bolt Catch Roll Pin	\$.75
10	LR-13	Magazine Catch	\$4.00
10A	LR-13A	Magazine Catch Assembly	\$8.00
11	LR-14	Detent Spring	\$.75
12	LR-15	Takedown Detent	\$.75
13	LR-16	Magazine Catch Spring	\$.75
14	LR-17	Magazine Catch Button, Aluminum	\$3.00
15	LR-18	Front Pivot Pin	\$4.00

16	LR-19	Disconnecter, A-15	\$6.00
17	LR-20/22	Trigger, A-15, w/Trigger Spring*	\$16.50
17A	LR-22	Trigger Spring	\$1.50
18	LR-23	Pistol Grip Screw	\$.50
19	LR-24	Pistol Grip Lock Washer	\$.30
20	LR-25	Pistol Grip, Black Plastic, A2	\$8.00
21	LR-26	Selector Spring	\$.75
22	LR-27	Detent, Selector	\$1.00
23	LR-28	Trigger Pin	\$1.25
23	LR-28	Hammer Pin	\$1.25
23A	LR-29A	Colt Logo, Sporter Trigger (Includes Hammer Pin)	\$5.00
25	LR-30	Takedown Pin	\$4.00
26	BS-12	Buttstock Aluminum Spacer	\$3.00
27	BS-13	Buttstock, A2, Plate & Door Assembly	\$57.95
28	BS-14	Buttstock Screw Upper, A2	\$2.00
28A	BS-14A	Buttstock Screw Upper, A1 (old)	\$2.00

PARDUS STOCK PARTS

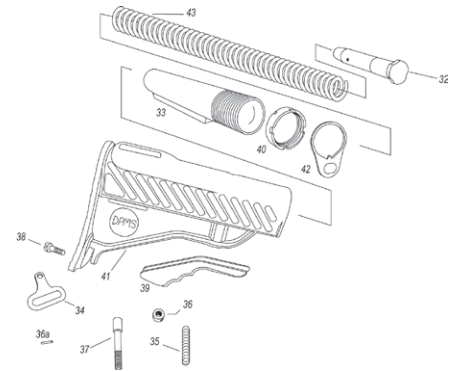

32	BS-11	Buffer Assembly CAR	\$18.95
33	CS-09-AP4	AP4 Buffer Tube	\$19.95
34	BS-05	Stock Swivel	\$3.00
35	CS-03	Latch Pin Spring	\$2.00
36	BS-M4-5	AP4 Stock Latch Pin Nut	\$3.99
36A	BL-03	Latch Nut Pin	\$.25
37	BS-M4-4	AP4 Stock Latch Pin	\$5.99
38	BS-M4-6	Sling Swivel Screw	\$1.99
40	CS-02	Castle Nut	\$4.00
41	CS-PS-12	Pardus Stock Body w/Latch	\$39.95
42	CS-01	Lock Plate	\$3.00
43	BS-10A	Buffer Spring CAR	\$4.95

CHARGING HANDLE

REPLACEMENT PARTS

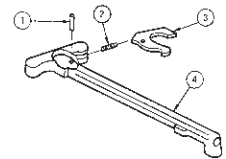

1	UR-16	Charging Handle Roll Pin	\$.50
2	UR-17	Charging Handle Latch Spring	\$1.00
3	UR-18	Charging Handle Latch	\$4.00
4	UR-19B	Stripped Handle	\$15.95
	UR-19	Charging Handle Assembly	\$19.95

NOTE: Parts 1-4 assembled, Black

BOLT

REPLACEMENT PARTS

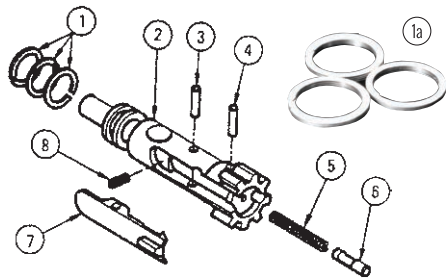

1	BT-01	Bolt Gas Rings (each)	\$1.00
1A	BT-01MF	McFarland One-Piece Gas Ring	\$2.95
2	BT-02	Bolt (each)	\$35.00
2A	BT-02A	Bolt w/Ejector (installed)	\$41.00
3	BT-03	Extractor Pin	\$1.00
4	BT-04	Ejector Roll Pin	\$.50
5	LR-26	Ejector Spring	\$.75
6	BT-06	Ejector	\$2.00
7	BT-07	Extractor	\$16.95
8	BT-08	Extractor Spring Assembly	\$1.50
	BT-09	Bolt Assembly (assembled)	\$49.00
	BT-9A	Bolt Assembly (unassembled)	\$48.00

TRIGGER

REPLACEMENT PARTS

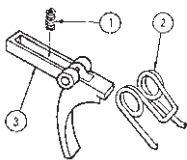

1	LR-31	Disconnecter Spring	\$.75
2	LR-22	Trigger Spring	\$1.50
3	LR-20	Trigger, A-15	\$15.95
	LR-21A	Trigger, "Horsey" Logo	\$36.95

BOLT ASSEMBLY

REPLACEMENT PARTS

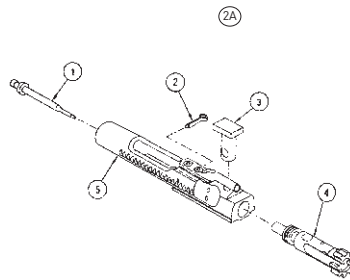

1	BT-14	Firing Pin, A-15	\$6.00
1A	BT-15	Firing Pin, M-16	\$6.95
2	BT-16	Firing Pin, Retaining Pin	\$0.75
2A	BT-16S	EM-16 Retaining Pin	\$6.99
3	BT-17	Cam Pin	\$5.00
4	BT-09	Bolt Assembly (assembled)	\$49.00
5	BT-19	Bolt Carrier & Key, A-15 & screws	\$65.00
5A	BT-20	Bolt Carrier & Key, EM-16 & screws	\$70.00
6	BCBA-1	Bolt Carrier & Bolt Assembly, A-15 (unassembled)	\$130.95
6A	BCBA-1AS	Bolt Carrier & Bolt Assembly, A-15 (assembled)	\$135.95
	BCBA-16	Bolt Carrier & Bolt Assembly, EM-16 (unassembled)	\$130.95
	BCBA-16AS	Bolt Carrier & Bolt Assembly, EM-16 (assembled)	\$135.95

HAMMER

REPLACEMENT PARTS

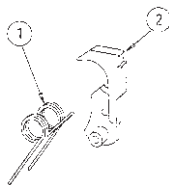

1	LR-32	Hammer Spring	\$1.50
2	LR-33K	Hammer A-15	\$21.49

BARREL

REPLACEMENT PARTS

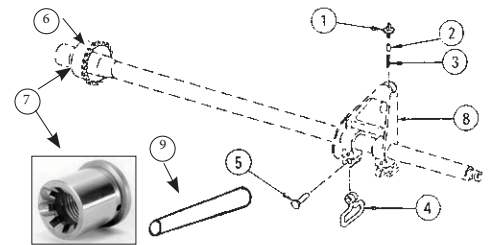

1	FS-01	Front Sight Post A2, Square	\$6.00
1A	FS-02	Front Sight Post A1, Round	\$5.00
1B	FS-08	FS-08 Extended	\$14.95
2	FS-03	Front Sight Detent	\$1.00
3	FS-04	Front Sight Spring	\$.50
4	BL-14	Front Swivel	\$2.09
5	BL-15	Front Swivel Rivet	\$.50
6	BL-16	Barrel Nut	\$8.00
7	BL-17	Barrel Extension	\$19.95
8	BL-18	Front Sight Base (not drilled)	\$34.95
	BL-18B	Front Sight (for DPMS 1" Bull Barrel)	\$39.95
9	FS-06	Front Sight Taper Pin (2 required)	\$.75 ea.

BOLT

REPLACEMENT PARTS

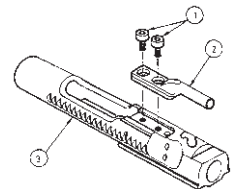

1	BT-10	Bolt Carrier Key Screw (2 required)	\$.50 ea.
2	BT-11	Bolt Carrier Key	\$10.95
3A	BT-13	Bolt Carrier, A-15	\$55.00

DPMS LR-308 SCHEMATIC

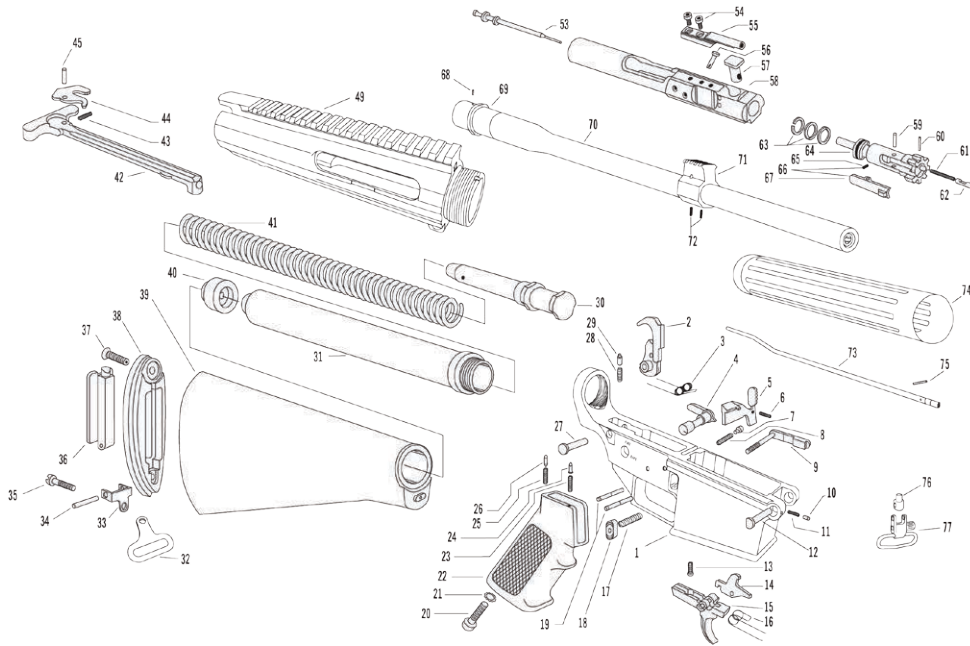

1	308-LR-05	308 Lower Receiver	\$409.95
2	LR-33K	Hammer w/J-Spring	\$21.49
3	LR-32	Hammer Spring	\$1.50
4	LR-08	Safety Selector	\$9.00
5	308-LR-11	Bolt Catch	\$9.95
6	308-LR-12	Bolt Catch Screw	\$5.95
7	LR-10	Bolt Catch Buffer	\$2.00
8	LR-09	Bolt Catch Spring	\$.75
9	LR-13	Magazine Catch	\$4.00
10	LR-15	Pivot Pin Detent	\$.75
11	LR-14	Pivot Pin Spring	\$.75
12	308-LR-18	Pivot Pin	\$8.95
13	LR-31	Disconnecter Spring	\$.75
14	LR-19	Disconnecter	\$6.00
15	LR-20	Trigger	\$15.95
16	LR-22	Trigger Spring	\$1.50
17	LR-16	Magazine Catch Spring	\$.75
18	LR-17	Magazine Catch Button	\$3.00
19	LR-28	Hammer & Trigger Pins (2)	\$1.25
20	LR-23	Pistol Grip Screw	\$.50
21	LR-24	Lock Washer	\$.30
22	LR-25	Pistol Grip	\$8.00
23	LR-26	Safety Detent Spring	\$.75
24	LR-27	Safety Detent	\$1.00

25	LR-14	Takedown Pin Spring	\$.75
26	LR-15	Takedown Pin Detent	\$.75
27	308-LR-30	Takedown Pin	\$8.95
28	LR-02	Buffer Retainer Spring	\$.75
29	LR-01	Buffer Retainer	\$1.50
30	308-BS-11	Buffer Assembly	\$29.95
31	BS-09	Buffer Tube	\$19.95
32	BS-05	Sling Swivel	\$3.00
33	BS-03	Access Door Hinge	\$1.50
34	BS-06	Access Door Hinge Pin	\$.75
35	BS-07	Rear Swivel Screw	\$1.25
36	BS-01K	Access Door Assembly	\$14.95
37	BS-14	Buttplate Screw	\$2.00
38	BS-02	Buttplate	\$3.00
39	BS-04	A2 Buttstock (only)	\$33.95
40	BS-12	Buttstock Spacer	\$3.00
41	308-BS-10B	Buffer Spring	\$9.95
42	308-UR-19B	Charging Handle	\$34.95
	308-UR-19	Charging Handle Assembly	\$49.95
43	UR-17	Charging Hndl. Latch Spring	\$1.00
44	UR-18	Charging Hndl. Latch	\$4.00
45	UR-16	Charging Hndl. Latch Roll Pin	\$.50
49	308-UR-36	Upper Receiver	\$189.95
53	308-BT-14	Firing Pin	\$19.95

54	BT-10	Bolt Carrier Key Screw (2)	\$.50
55	BT-11	Bolt Carrier Key	\$10.95
56	308-BT-16	Firing Pin Retaining Pin	\$6.95
57	308-BT-17	Cam Pin	\$11.95
58	308-BT-12	Bolt Carrier	\$105.95
59	308-BT-03	Extractor Pin	\$1.95
60	BT-04	Ejector Roll Pin	\$.50
61	308-BT-05	Ejector Spring	\$1.99
62	308-BT-06	Ejector	\$2.95
63	308-BT-01	Bolt Gas Rings (3)	\$2.95
64	308-BT-02	Bolt (Stripped)	\$89.95
65	308-BT-08	Extractor Spring	\$2.49
66	308-BT-07K	.308 Extractor with Spring	\$41.95
67	308-BT-07	Extractor	\$39.95
68	BL-17-1	Barrel Extension Pin	\$1.50
69	308-BL-17	Barrel Extension	\$59.95
70	308-BL-24	Barrel, 24"	\$299.95
71	308-GB-SR9	Single Rail Gas Block	\$69.95
72	GB-SS	Gas Block Set Screws (2)	\$1.30
73	BL-04	Gas Tube	\$15.00
73	308-FF-02	Free-Float Tube Assembly	\$59.95
75	BL-03	Gas Tube Roll Pin	\$.25
76	BI-FFS	Bipod Stud	\$4.65
77	SL-SW	Sling Swivel	\$4.99

DPMS LR-308 AP4 SCHEMATIC

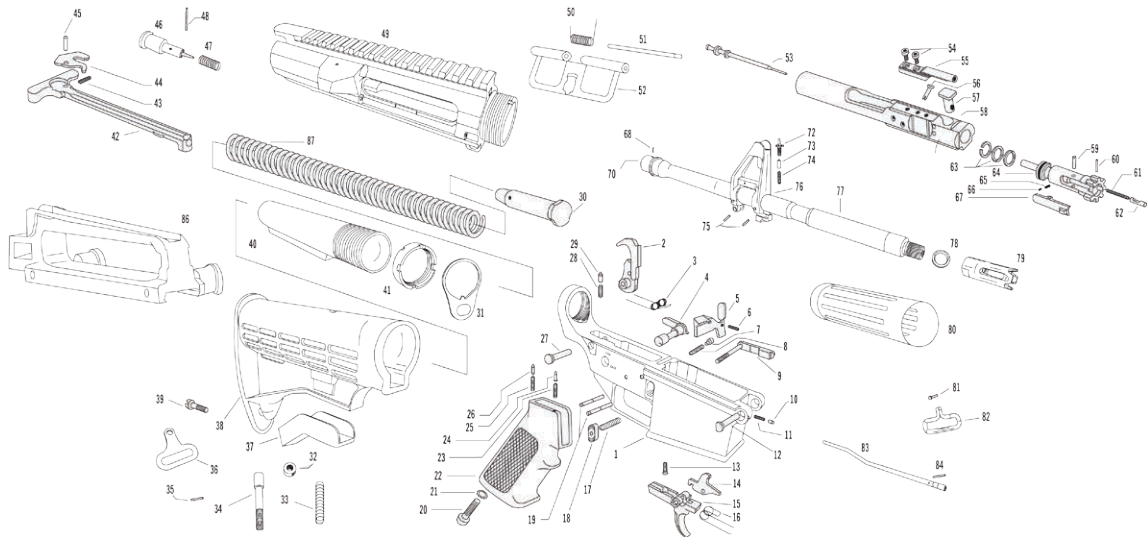

1	308-LR-05	308 Lower Receiver	\$409.95
2	LR-33K	Hammer w/J-Spring	\$21.49
3	LR-32	Hammer Spring	\$1.50
4	LR-08	Safety Selector	\$9.00
5	308-LR-11	Bolt Catch	\$9.95
6	308-LR-12	Bolt Catch Screw	\$5.95
7	LR-10	Bolt Catch Buffer	\$2.00
8	LR-09	Bolt Catch Spring	\$.75
9	LR-13	Magazine Catch	\$4.00
10	LR-15	Pivot Pin Detent	\$.75
11	LR-14	Pivot Pin Spring	\$.75
12	308-LR-18	Pivot Pin	\$8.95
13	LR-31	Disconnecter Spring	\$.75
14	LR-19	Disconnecter	\$6.00
15	LR-20	Trigger	\$15.95
16	LR-22	Trigger Spring	\$1.50
17	LR-16	Magazine Catch Spring	\$.75
18	LR-17	Magazine Catch Button	\$3.00
19	LR-28	Hammer & Trigger Pins (2)	\$1.25
20	LR-23	Pistol Grip Screw	\$.50
21	LR-24	Lock Washer	\$.30
22	LR-25	Pistol Grip	\$8.00
23	LR-26	Safety Detent Spring	\$.75
24	LR-27	Safety Detent	\$1.00
25	LR-14	Takedown Pin Spring	\$.75
26	LR-15	Takedown Pin Detent	\$.75
27	308-LR-30	Takedown Pin	\$8.95
28	LR-02	Buffer Retainer Spring	\$.75

29	LR-01	Buffer Retainer	\$1.50
30	308-CS-10B	Buffer Assembly	\$24.95
31	CS-01	Lock Plate	\$3.00
32	BS-M4-5	Stock Latch Pin Nut	\$3.99
33	CS-03	Latch Pin Spring	\$2.00
34	BS-M4-4	Stock Latch Pin	\$5.99
35	BL-03	Latch Nut Pin	\$.25
36	BS-05	Stock Swivel	\$3.00
37/38	CS-12	AP4 Stock Body	\$29.95
39	BS-M4-6	Sling Swivel Screw	\$1.99
40	CS-09-AP4	Buffer Tube	\$19.95
41	CS-02	Castle Nut	\$4.00
42	308-UR-19B	Charging Handle	\$34.95
43	308-UR-19	Charging Handle Assembly	\$49.95
44	UR-17	Charging Handle Latch Spring	\$1.00
45	UR-18	Charging Handle Latch	\$4.00
46	UR-16	Charging Handle Latch Roll Pin	\$.50
47	UR-08-RA	Forward Assist Assembly	\$13.95
48	308-UR-07	Forward Assist Spring	\$1.75
49	UR-06	Forward Assist Pin	\$.75
50	308-FTT-EA	Upper Receiver	\$169.95
51	UR-05	Ejection Port Cover Spring	\$.75
52	308-UR-03	Ejection Port Cover Pin	\$2.95
53	308-UR-05	Ejection Port Cover	\$24.95
54	BT-10	Firing Pin	\$19.95
55	BT-11	Firing Pin Retaining Pin	\$6.95

57	308-BT-17	Cam Pin	\$11.95
58	308-BT-12	Bolt Carrier	\$105.95
59	308-BT-03	Extractor Pin	\$1.95
60	BT-04	Ejector Roll Pin	\$.50
61	308-BT-05W	Ejector Spring	\$1.99
62	308-BT-06	Ejector	\$2.95
63	308-BT-01	Bolt Gas Rings (3)	\$2.95
64	308-BT-02	Bolt (Stripped)	\$89.95
65	308-BT-08	Extractor Spring	\$2.49
66	308-BT-07K	Extractor with Spring	\$2.49
67	308-BT-07	Extractor	\$39.95
68	BL-17-1	Barrel Extension Pin	\$1.50
70	308-BL-17	Barrel Extension	\$59.95
72	FS-08	Front Sight	\$14.95
73	FS-03	Front Sight Detent	\$1.00
74	FS-04	Front Sight Spring	\$.50
75	FS-06	Taper Pins (2)	\$.75
76	BL-18	Front Sight Base	\$34.95
77	308-BL-AP4	Barrel, 16"	\$299.95
78	308-BL-06-CW	Crush Washer	\$3.39
79	308-BL-YH	Panther Flash Hider	\$44.95
80	308-FF-01	Free-Float Tube	\$59.95
81	BL-15	Sling Swivel Rivet	\$.50
82	BL-14	Sling Swivel	\$2.09
83	BL-04A	Carbine Gas Tube	\$15.00
84	BL-03	Gas Tube Roll Pin	\$.25
86	308-DCH	Detachable Carry Handle	\$139.95
87	308-CS-10A	Buffer Spring	\$5.39

DPMS

BULL 24 SCHEMATIC

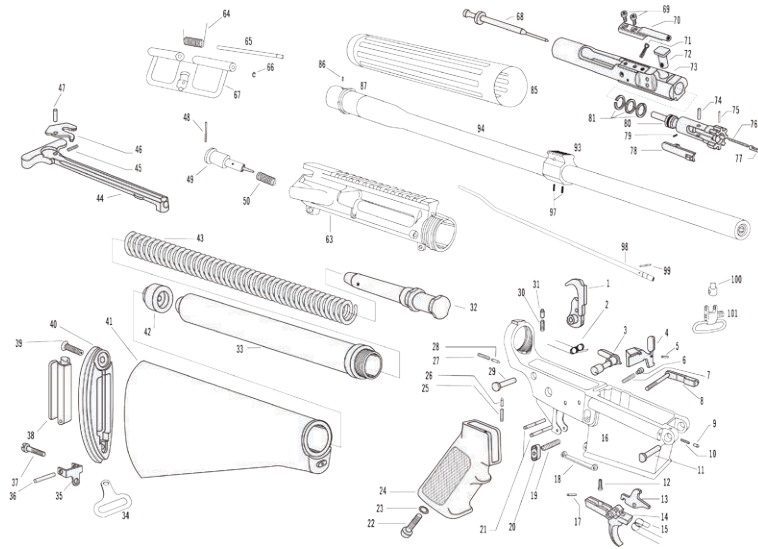

1	LR-33K	Hammer w/J-Spring	\$21.49
2	LR-32	Hammer Spring	\$1.50
3	LR-08	Safety Selector	\$9.00
4	LR-11	Bolt Catch	\$9.00
5	LR-12	Bolt Catch Screw	\$.75
6	LR-10	Bolt Catch Buffer	\$2.00
7	LR-09	Bolt Catch Spring	\$.75
8	LR-13	Magazine Catch	\$4.00
9	LR-15	Pivot Pin Detent	\$.75
10	LR-14	Pivot Pin Spring	\$.75
11	LR-18	Pivot Pin	\$4.00
12	LR-31	Disconnecter Spring	\$.75
13	LR-19	Disconnecter	\$6.00
14	LR-20	Trigger	\$15.95
15	LR-22	Trigger Spring	\$1.50
16	LR-05FF	Forged Lower Receiver	\$165.95
17	LR-04	Trigger Guard Pin	\$.75
18	LR-03	Trigger Guard	\$7.00
19	LR-16	Magazine Catch Spring	\$.75
20	LR-17	Magazine Catch Button	\$3.00
21	LR-28	Hammer & Trigger Pins (2)	\$1.25
22	LR-23	Pistol Grip Screw	\$.50
23	LR-24	Lock Washer	\$.30
24	LR-25	A2 Pistol Grip	\$8.00
25	LR-26	Safety Detent Spring	\$.75
26	LR-27	Safety Detent	\$1.00

27	LR-14	Takedown Pin Spring	\$.75
28	LR-15	Takedown Pin Detent	\$.75
29	LR-30	Takedown Pin	\$4.00
30	LR-02	Buffer Retainer Spring	\$.75
31	LR-01	Buffer Retainer	\$1.50
32	BS-11	Buffer Assembly	\$18.95
33	BS-09	Buffer Tube	\$19.95
34	BS-05	Sling Swivel	\$3.00
35	BS-03	Access Door Hinge	\$1.50
36	BS-06	Access Door Hinge Pin	\$.75
37	BS-07	Rear Swivel Screw	\$1.25
38	BS-01K	Access Door Assembly	\$14.95
39	BS-14	Buttplate Screw	\$2.00
40	BS-02	Buttplate	\$3.00
41	BS-04	Buttstock	\$33.95
42	BS-12	Buttstock Spacer	\$3.00
43	BS-10B	Buffer Spring	\$4.95
44	UR-19B	Charging Handle	\$15.95
45	UR-17	Charging Handle Latch Spring	\$1.00
46	UR-18	Charging Handle Latch	\$4.00
47	UR-16	Charging Handle Latch Roll Pin	\$.50
48	UR-06	Forward Assist Pin	\$.75
49	UR-08-RA	Forward Assist Only, Round	\$13.95
50	UR-07	Forward Assist Spring	\$.75
63	FTT-EA	A3 Upper Receiver	\$125.00
64	UR-05	Dust Cover Spring	\$.75

65	UR-03	Dust Cover Pin	\$1.50
66	UR-02	Ejection Port Cover Hinge Pin	\$.50
67	UR-04	Dust Cover	\$5.75
68	BT-14	Firing Pin	\$6.00
69	BT-10	Bolt Carrier Key Screw (2)	\$.50
70	BT-11	Bolt Carrier Key	\$10.95
71	BT-16	Firing Pin Retaining Pin	\$.75
72	BT-17	Cam Pin	\$5.00
73	BT-13	Bolt Carrier	\$55.00
74	BT-03	Extractor Pin	\$1.00
75	BT-04	Ejector Roll Pin	\$.50
76	LR-26	Ejector Spring	\$.75
77	BT-06	Ejector	\$2.00
78	BT-07	Extractor	\$16.95
79	BT-08	Extractor Spring	\$1.50
80	BT-02	Bolt	\$35.00
81	BT-01	Bolt Gas Rings (3)	\$1.00
85	FF-02	Std. Free-Float Tube	\$53.95
86	BL-17-1	Barrel Extension Pin	\$1.50
87	BL-17	Barrel Extension	\$19.95
93	GB-SR9	Single Rail gas block	\$49.99
94	BULL-01-24	Barrel, 24"	\$279.00
97	GB-SS	Gas Block Set Screws (2)	\$1.30
98	BL-04	Gas Tube	\$15.00
99	BL-03	Gas Tube Roll Pin	\$.25
100	BI-FFS	Bipod Stud	\$4.65
101	SL-SW	Sling Swivel	\$4.99

DPMS

AP4 CARBINE SCHEMATIC

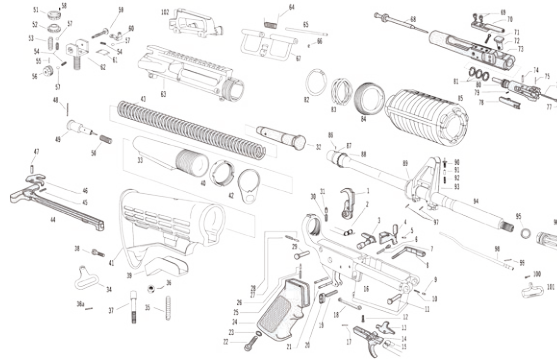

1	LR-33K	Hammer w/J-Spring	\$21.49
2	LR-32	Hammer Spring	\$1.50
3	LR-08	Safety Selector	\$9.00
4	LR-11	Bolt Catch	\$9.00
5	LR-12	Bolt Catch Screw	\$.75
6	LR-10	Bolt Catch Buffer	\$2.00
7	LR-09	Bolt Catch Spring	\$.75
8	LR-13	Magazine Catch	\$4.00
9	LR-15	Pivot Pin Detent	\$.75
10	LR-14	Pivot Pin Spring	\$.75
11	LR-18	Pivot Pin	\$4.00
12	LR-31	Disconnecter Spring	\$.75
13	LR-19	Disconnecter	\$6.00
14	LR-20	Trigger	\$15.95
15	LR-22	Trigger Spring	\$1.50
16	LR-05FF	Forged Lower Receiver	\$189.95
17	LR-04	Trigger Guard Pin	\$.75
18	LR-03	Trigger Guard	\$7.00
19	LR-16	Magazine Catch Spring	\$.75
20	LR-17	Magazine Catch Button	\$3.00
21	LR-28	Hammer & Trigger Pins (2)	\$1.25
22	LR-23	Pistol Grip Screw	\$.50
23	LR-24	Lock Washer	\$.30
24	LR-25	A2 Pistol Grip	\$8.00
25	LR-26	Safety Detent Spring	\$.75
26	LR-27	Safety Detent	\$1.00
27	LR-14	Takedown Pin Spring	\$.75
28	LR-15	Takedown Pin Detent	\$.75
29	LR-30	Takedown Pin	\$4.00
30	LR-02	Buffer Retainer Spring	\$.75
31	LR-01	Buffer Retainer	\$1.50
32	BS-11A	Buffer Assembly	\$15.00
33	CS-09-AP4	Buffer Tube	\$19.95
34	BS-05	Stock Swivel	\$3.00

35	CS-03	Latch Pin Spring	\$2.00
36	BS-M4-5	Stock Latch Pin Nut	\$3.99
36A	BL-0	Latch Nut Pin	\$.25
37	BS-M4-4	Stock Latch Pin	\$5.99
38	BS-M4-6	Sling Swivel Screw	\$1.99
39/41	CS-AP4S	Stock Body & Latch	\$49.95
40	CS-02	Castle Nut	\$4.00
42	CS-01	Lock Plate	\$3.00
43	BS-10A	Buffer Spring	\$4.95
44	UR-19B	Charging Handle	\$15.95
45	UR-17	Charg. Handle Latch Spring	\$1.00
46	UR-18	Charging Handle Latch	\$4.00
47	UR-16	Charging Handle Latch Roll Pin	\$.50
48	UR-06	Forward Assist Pin	\$.75
49	UR-08-RA	Forward Assist Only, Round	\$13.95
50	UR-07	Forward Assist Spring	\$.75
51	UR-33A	Rear Base Index Elevation	\$6.95
52	UR-34A	Rear Base Elevation Knob	\$6.00
53	UR-31A	Rear Base Elevation Knob Spring	\$1.00
54	UR-24	Rear Base Springs (3)	\$.75
55	UR-22	Rear Base Spring Pin	\$.75
56	UR-23	Rear Base Windage Knob	\$6.00
57	UR-25	Rear Base Ball Bearing (3)	\$.50
58	UR-32	Rear Base Index Screw	\$2.00
59	UR-26	Rear Base Windage Knob Screw	\$4.00
60	UR-27	Rear Base Aperture	\$9.00
61	UR-28	Rear Base Flat Spring	\$1.00
62	UR-29	Rear Base Lug	\$18.95
63	FTT-EA	A3 Upper Receiver	\$125.00
64	UR-05	Dust Cover Spring	\$.75
65	UR-03	Dust Cover Pin	\$1.50
66	UR-02	Ejection Port Cover Hinge Pin Snap	\$.50
67	UR-04	Dust Cover	\$5.75
68	BT-14	Firing Pin	\$6.00

69	BT-10	Bolt Carrier Key Screw (2)	\$.50
70	BT-11	Bolt Carrier Key	\$10.95
71	BT-16	Firing Pin Retaining Pin	\$.75
72	BT-17	Cam Pin	\$5.00
73	BT-13	Bolt Carrier	\$55.00
74	BT-03	Extractor Pin	\$1.00
75	BT-04	Ejector Roll Pin	\$.50
76	LR-26	Ejector Spring	\$.75
77	BT-06	Ejector	\$2.00
78	BT-07	Extractor	\$16.95
79	BT-08	Extractor Springs	\$1.50
80	BT-02	Bolt	\$35.00
81	BT-01	Bolt Gas Rings (3)	\$1.00
82	BL-07	Barrel Spring Ring	\$1.50
83	BL-08	Barrel Spring	\$5.00
84	BL-09	Delta Ring	\$7.00
85	BL-FG	GlacierGuard Handguards	\$39.95
86	BL-17-1	Barrel Extension Pin	\$1.50
87	BL-17	Barrel Extension	\$19.95
88	BL-16	Barrel Nut	\$8.00
89	BL-19	Round Handguard End Cap	\$4.00
90	FS-01	Front Sight	\$6.00
91	FS-03	Front Sight Detent	\$1.00
92	FS-04	Front Sight Spring	\$.50
93	BL-18	Front Sight Base	\$34.95
94	BL-11-AP4	AP4 Contour Barrel, 16"	\$189.00
95	BL-06-CW	Crush Washer	\$2.99
96	BL-06-A2	A2 Flash Hider	\$8.00
97	FS-06	Taper Pins (2)	\$.75
98	BL-04A	Carbine Gas Tube	\$15.00
99	BL-03	Gas Tube Roll Pin	\$.25
100	BL-15	Sling Swivel Rivet	\$.50
101	BL-14	Sling Swivel	\$2.09

DPMS EQUIPMENT UPGRADES

UPGRADES THAT PLACE YOU AHEAD OF THE GAME

.338, .308, .260, .243, AND 6.5 CALIBER UPGRADES		HANDGUARD UPGRADES	
UPPER RECEIVER UPGRADES		A2 Handguards to Free-Float Tube	UG-16 \$50
Upgrade from Slick-Side Receiver to A3-Style Receiver	UG-308A3 \$79.95	A2 Handguards to Free-Float Tube, Vented	UG-17 \$65
COMPENSATOR UPGRADE		Standard Free-Float to Vented	UG-19 \$48
.308 Panther Flash Hider to 308 Miculek Comp	UG-308MIC \$24.95	GlacierGuard to Carbine Free-Float	UG-21 \$50
BOLT CARRIER UPGRADE		GlacierGuard to Carbine Free-Float, Vented	UG-22 \$75
.308 Steel Carrier to 308 Chrome Carrier	UG-308CBC \$50.00	GlacierGuard to 4-Rail Carbine FFT	UG-4R \$149
BUTTSTOCK UPGRADES		Standard Free-Float Tube to 4-Rail Std. FFT	UG-ST4 \$149
.308 Buttstock to Magpul® 308 PRS Stock	UG-308PRS \$230.00	Upgrade to Carbon Fiber FFT	UG-CF \$59.95
.308 AP4 Buttstock to 308 A2 Stock	UG-308A2 \$9.95	Hogue® Soft Rubber Free-Float Tube, Carbine	UG-HFFC \$99.95
HANDGUARD UPGRADES		BARREL UPGRADES	
For use with the .308 A3-style Upper Receiver		Chromelined Bore and Chamber, 4150 Steel	UG-CH \$32
.308 Free-Float to 308 4-Rail Free-Float, Std. Length	UG-3084S \$159.95	Barrel Fluting, Full Flutes	UG-34 \$65
.308 Free-Float to 308 4-Rail Free-Float, Car. Length	UG-3084C \$159.95	Barrel Threading	UG-THREAD \$50
.308 Free-Float to 308 Vented Free-Float, Std. Length	UG-308FFVSTD \$19.95	Black Teflon® Barrel	UG-46 \$39.95
.308 Free-Float to 308 Vented Free-Float, Car. Length	UG-308FFVCAR \$19.95	Bead Blast Barrel	UG-47 \$30
.308 Free-Float to 308 Carbon Fiber Free-Float Std. Length	UG-308-CF \$109.89	COMPENSATOR UPGRADES	
.308 Free-Float to 308 Carbon Fiber Free-Float Car. Length	UG-308-CFC \$109.89	A2 Flash Hider to Panther Flash Hider	UG-PF \$19.95
For use with the .308 Slick-Side Upper Receiver		A2 Flash Hider to Miculek Comp	UG-MIC 39.95
.308 Free-Float to 308 4-Rail Free-Float, Std. Length	UG-3084SH \$159.95	A2 Flash Hider to Cooley Tactical Compensator	UG-BCT \$85.95
.308 Free-Float to 308 4-Rail Free-Float, Car. Length	UG-3084CH \$159.95	BOLT CARRIER UPGRADES	
		Steel to Chromium, Assembled	UG-70 \$39.05
		Steel to Diamond Coat, Assembled	UG-70D \$65
		Steel to Titanium Nitride, Assembled	UG-71 \$65

BOLT CATCH UPGRADES		FRONT SIGHT POST UPGRADES	
Std. Bolt Catch to Tactical Bolt Catch	UG-T11 \$18.95	Standard A2 Sight to National Match .050	UG-59 \$21.95
Std. Bolt Catch to Norgon Ambi-Bolt Catch	UG-NORGON \$85.85		
CHARGING HANDLE UPGRADES		REAR SIGHT UPGRADES	
Standard Charging Handle to Tactical Latch	UG-73 \$43.95	Standard A2 Rear Sight to X.S. Sight Ghost Ring	UG-64 \$33.95
		Standard A2 Rear Sight to .046/.200	UG-65 \$19.95
SAFETY SELECTOR UPGRADES		Standard A2 Rear Sight to .052/.200	UG-66 \$19.95
Standard Selector to LR-08B Ambi Safety	UG-87 \$35.95	Standard A2 Rear Sight to .030/.040	UG-67 \$19.95
Standard Selector to LR-08D Tactical Selector	UG-88 \$19.95	Detachable Carry Handle to Flattop Rear Sight	UG-RS N/C
RIFLE CONFIGURATION		PISTOL GRIP UPGRADES	
Upgrade from Pre-Ban to Post-Ban Configuration	UG-POST \$20	Standard A2 Pistol Grip to Panther Grip	UG-78 \$48.95
		Standard A2 Pistol Grip to SPR Grip	UG-79 \$50.95
STOCK UPGRADES		Standard A2 Pistol Grip to Hogue Grip	UG-HPG \$27.95
A2 Stock to Adjustable A2 Stock (BS-27)	UG-27 \$160	Standard A2 Pistol Grip to ERGO Sure Grip	UG-82 \$22.95
A2 Stock to 6-Position AP4 Stock	UG-6P N/C	Standard A2 Pistol Grip to ERGO Ambi-Grip	UG-83 \$22.95
A2 Stock to Pardus Stock, Black	UG-6S N/C	TRIGGER UPGRADES	
Pardus Stock to A2 Stock	UG-A2 \$61	JP Adjustable Trigger	UG-69 \$129.95
A2 Stock to ACE Shorty Skeleton Stock	UG-ACE-S \$85.95	Install Jard Trigger	UG-JT \$169.95
A2 Stock to ACE SOCOM Stock	UG-AS 160	DPMS Two-Stage Trigger Upgrade	UG-TS \$105.95
A2 Stock to ACE LTD Fixed Stock	UG-ACE \$69.95	JP Trigger to Two-Stage Trigger	UG-JPRR N/C
AP4 Stock to LMT Sopmod Stock	UG-LMT \$244.95		
AP4 Stock to Magpul® CTR Carbine Stock	UG-MAG310-BLK \$115		
A2 Stock to Magpul® PRS Stock	UG-PRS-B \$230		

DPMS, DPMS Panther Arms, and Tapco are trademarks of RA Brands, L.L.C. Blackout and Brakeout are trademarks of Advanced Armament Corp., LLC. Ace is a trademark of Ace, Ltd. Aimpoint is a trademark of Aimpoint AB Corporation. Arredondo is a trademark of Arredondo Accessories. ATI is a trademark of Advanced Technology International. Badger is a trademark of Badger Ordnance. BCM is a trademark of Bravo Company MFG, Inc.. Beta Mag is a trademark of The Beta Company. Blackhawk is a trademark of Alliant Techsystems, Inc.. Bore Snake is a trademark of Bushnell, Inc.. Colt is a trademark of Colt's Manufacturing Company, LLC. Cammenga is a trademark of Cammenga Company, LLC. Crimson Trace is a trademark of Crimson Trace Corporation. CSAI is a trademark of Paul Howe. DSC is a trademark of DSC Arms, Inc.. Eotech is a trademark of L-3 Communications. Ergo Z-Rail is a trademark of Del-Ton, Inc.. Falcon Industries is a trademark of Falcon Industries, Inc.. Hi-Viz is a trademark of Hi Viz Shooting Systems. Hogue is a trademark of Hogue, Inc.. Hoppes is a trademark of Bushnell Outdoor Products. Jard is a trademark of Jard, Inc.. Jewell is a trademark of Jewell Triggers, Inc.. JP is a trademark of JP Enterprises, Inc.. Lancer Systems is a trademark of Lancer Systems. Lan World is a trademark of Land World, Inc.. Leupold is a trademark of Leupold & Stevens, Inc.. Magpul is a trademark of Magpul Industries Corp.. MantaRails is a trademark of Advanced Innovation and Manufacturing, Inc.. Masen is a trademark of John Masen Co.. Meproflight is a trademark of Meproflight Ltd. Midwest Industries is a trademark of Midwest Industries, Inc.. Mossy Oak Brush is a trademark of Haas Outdoors, Inc.. Nikon is a trademark of Nikon Corporation. Nordic Components is a trademark of Nordic Components. Ambi-Catch is a trademark of Norgon, LLC. Noveske is a trademark of Noveske Rifleworks, LLC. Otis is a trademark of Otis Technology. Plano is a trademark of Plano Molding Co. Precision Reflex is a trademark of Precision Reflex, Inc.. Sierra Precision is a trademark of Sierra Precision Rifles. SOG is a trademark of SOG Armory. Spec-Ops is a trademark of Best Made Designs, LLC. Stark is a trademark of Stark Equipment Corp. SureFire is a trademark of SureFire, LLC. Tac-Ops is a trademark of a Tactical Operations, Inc.. Trijicon is a trademark of Trijicon, Inc.. Troy Industries is a trademark of Troy Industries, Inc.. Turner Saddlery is a trademark of Turner Saddlery, Inc.. Valdada is a trademark of Valdada Optics. Vickers Combat is a trademark of Vickers Tactical, Inc.. Warne is a trademark of Warne Scope Mounts. Wilson Combat is a trademark of Wilson Combat. Wolff is a trademark of W.C. Wolff Company. XS Sight Systems is a trademark of XS Sight Systems, Inc.. YHM is a trademark of Yankee Hill Machine Co., Inc..